

LCOS 10.90

VoIP

02/2025



LANCOM
SYSTEMS

Contents

1 Voice over IP – VoIP	5
1.1 Introduction.....	5
1.2 VoIP implementation in LANCOM VoIP routers.....	6
1.2.1 Example applications.....	6
1.2.2 The central position of the LANCOM VoIP router.....	9
1.3 Call switching: Call routing.....	11
1.3.1 SIP proxy and SIP gateway.....	12
1.3.2 User registration at the SIP proxy.....	12
1.3.3 Number translation at network transitions.....	15
1.3.4 The Call Manager.....	15
1.3.5 Telephony with LANCOM VoIP routers.....	16
1.3.6 Hold call, swap call, transfer call.....	19
1.3.7 Transmission of DTMF tones.....	19
1.4 Configuring the VoIP parameters.....	21
1.4.1 General settings.....	21
1.4.2 Line configuration.....	22
1.4.3 Configuration of users.....	41
1.5 Call Manager Configuration.....	53
1.5.1 Process of call routing.....	53
1.5.2 Handling the calling party ID.....	53
1.5.3 Call-routing table parameters.....	55
1.5.4 Signaling parallel calls in the ISDN.....	60
1.5.5 Extended settings.....	61
1.6 Telephony (PBX) functions in LANCOM VoIP routers.....	63
1.6.1 Transfer and forward call.....	63
1.6.2 Spontaneous call management by the user.....	67
1.6.3 Configure permanent call forwarding.....	69
1.6.4 Call forwarding (call deflection / partial rerouting) at the SIP trunk (SIP 302).....	70
1.6.5 Fax via T.38 – Fax over IP (FoIP).....	70
1.6.6 Hunt groups with call distribution.....	71
1.6.7 Multiple logins (multi login).....	73
1.7 VoIP media proxy – Optimized management for SIP connections.....	73
1.8 SIP-ID as switchboard number with trunk lines.....	75
1.9 Switching at the SIP provider.....	76
1.10 SIP Application Layer Gateway (SIP ALG).....	77
1.10.1 Properties.....	77
1.10.2 Configuration.....	77
1.11 Restricting or preventing SIP registration over WAN.....	78
1.12 Certificates for encrypted telephony.....	78

1.13 Handling canonical telephone numbers.....	80
1.14 Processing Destination Domains.....	80
1.14.1 Registration at upstream exchanges.....	80
1.14.2 Switching internal calls.....	81
1.15 Configuring the ISDN interfaces.....	81
1.15.1 Point-to-multipoint and point-to-point connections.....	81
1.15.2 Bus termination.....	82
1.15.3 Protocol settings.....	82
1.15.4 ISDN connection timing.....	82
1.16 Configuration examples.....	83
1.16.1 VoIP telephony in stand-alone operation.....	83
1.16.2 Using VoIP telephony to enhance the upstream ISDN PBX.....	89
1.16.3 Connecting to an upstream SIP PBX.....	96
1.16.4 VoIP connectivity between sites without a SIP PBX.....	100
1.16.5 SIP trunking.....	104
1.16.6 Block outgoing calls to service numbers.....	106
1.16.7 Rejecting incoming calls.....	107
1.16.8 Reject calls without a calling number.....	108
1.16.9 Forwarding calls without a calling number.....	109
1.17 Diagnosis of VoIP connections.....	109
1.17.1 SIP traces.....	109
1.17.2 Connection diagnosis with LANmonitor.....	109
1.18 VoSIP support in the Voice Call Manager.....	111
1.19 Auto provisioning LANCOS DECT 510 IP.....	112
1.19.1 Configuring DECT base stations and handsets with LANconfig.....	112

Copyright

© 2025 LANCOM Systems GmbH, Würselen (Germany). All rights reserved.

While the information in this manual has been compiled with great care, it may not be deemed an assurance of product characteristics. LANCOM Systems shall be liable only to the degree specified in the terms of sale and delivery.

The reproduction and distribution of the documentation and software supplied with this product and the use of its contents is subject to written authorization from LANCOM Systems. We reserve the right to make any alterations that arise as the result of technical development.

Windows® and Microsoft® are registered trademarks of Microsoft, Corp.

LANCOM, LANCOM Systems, LCOS, LANcommunity and Hyper Integration are registered trademarks. All other names or descriptions used may be trademarks or registered trademarks of their owners. This document contains statements relating to future products and their attributes. LANCOM Systems reserves the right to change these without notice. No liability for technical errors and/or omissions.

This product contains separate open-source software components which are subject to their own licenses, in particular the General Public License (GPL). The license information for the device firmware (LCOS) is available on the device's WEBconfig interface under "Extras > License information". If the respective license demands, the source files for the corresponding software components will be made available on a download server upon request.

Products from LANCOM Systems include software developed by the "OpenSSL Project" for use in the "OpenSSL Toolkit" (www.openssl.org).

Products from LANCOM Systems include cryptographic software written by Eric Young (ey@cryptsoft.com).

Products from LANCOM Systems include software developed by the NetBSD Foundation, Inc. and its contributors.

Products from LANCOM Systems contain the LZMA SDK developed by Igor Pavlov.

LANCOM Systems GmbH

A Rohde & Schwarz Company

Adenauerstr. 20/B2

52146 Würselen

Germany

www.lancom-systems.com

1 Voice over IP – VoIP

1.1 Introduction

Voice over IP (VoIP) stands for voice communication in computer networks based on the Internet protocol (IP). The core idea is to provide the functions of traditional telephony via cost-effective and wide-spread networking structures such as the Internet. VoIP itself is not a standard, rather it is a collective term for the various technologies (equipment, protocols, voice encoding, etc.) which make voice communications in IP networks possible.

A variety of terminology is used to describe telephony over a network (LAN or Internet). The terms "Voice over IP" or "IP telephony" are used as synonyms, although in actual fact they have different meanings.

- Strictly speaking, "Voice over IP" is merely a term for the technology of transmitting calls across data networks in real-time using the IP protocol (Internet protocol). The term is also used when the technology is implemented only in the provider's core networks, in what is known as the backbone
- The term "IP telephony" is used when the VoIP technology is also used in the terminal equipment, so that the call subscriber uses the IP network for telephony.
- "Internet telephony" is also used to describe telephony using VoIP over the Internet in general.

In the following, "Voice over IP" is usually used even to refer to IP telephony in accordance with general custom.

There are four basic types of terminal equipment that can be used for VoIP telephony:

- With software running on the PC, known as a "softphone".
- With an IP or VoIP telephone that is connected directly to the local network.
- With a conventional telephone that is connected to the local network by an adapter (analog telephone adapter, ATA).
- Via a VoIP gateway that converts telephone calls from telephones (analog and ISDN) to VoIP and can then communicate between the two "telephone worlds" like a PBX.

There is a basic difference between a VoIP connection being established between two pieces of terminal equipment that are connected directly to the data network (PC or IP telephone) and the situation where a subscriber in the land-line or mobile telephone network requires the translation of the signaling, numbers and voice data. To differentiate the various connection variants, a device in the LAN has become known as a "PC", and a device in the land-line network has become known as a "phone".

PC-to-PC communication

With this application, the terminal equipment has to be integrated directly into the user's LAN. Examples are a PC, an IP telephone or a telephone that is connected to the LAN using an ATA.

Different software solutions are available for the PC, known as "softphones". Note that some of these programs can only communicate with users of the same software and not with softphones from other manufacturers. Communication is usually free of charge within the Internet. A current example is Skype, which uses its own protocol.

PC-to-phone and phone-to-PC communication

In this case, the call data has to be transmitted from the Internet to the landline network, usually using what are known as VoIP gateways. In general, these gateways are provided by providers and are subject to a fee.

So that the subscriber can even be called on a PC, he or she needs a VoIP telephone number that is usually provided by a provider.

VoIP providers usually only provide individual numbers and not complete number ranges with a switchboard number and extension numbers. This is why the numbers that are provided by public providers are not attractive to many business customers. When the LANCOM VoIP router is used with a SIP gateway, previously-used numbers can be maintained; the functions of VoIP telephony can also be used.

1.2 VoIP implementation in LANCOM VoIP routers

The main task of the VoIP implementation in the LANCOM VoIP router is to connect telephone calls from different local interfaces (LAN, WLAN, ISDN) to the WAN connections that can be accessed by the router. This enables switching between the local interfaces (local call) and also the WAN interfaces.

The basis for the implementation and switching is the SIP protocol. The calls over all interfaces are converted into SIP by the interface translator (this mainly concerns the ISDN interfaces).

Furthermore, the bit-transparent connection is usually used for calls between multiple local ISDN interfaces to achieve the highest possible compatibility and quality.

1.2.1 Example applications

Voice over IP solutions offer advantages for a broad spectrum of applications, starting with small companies and extending to large corporations with extensive networks of subsidiaries. In the following section, we will demonstrate a number of examples.

 Detailed information about the configuration is available in the chapter 'Configuration of VoIP functions'.

Supplementing existing ISDN PBXs

VoIP functions can be conveniently added in to existing telephone structures by using a LANCOM VoIP router. The LANCOM VoIP router is simply connected between the public ISDN connection (e.g. ISDN NTBA) and the ISDN PBX.

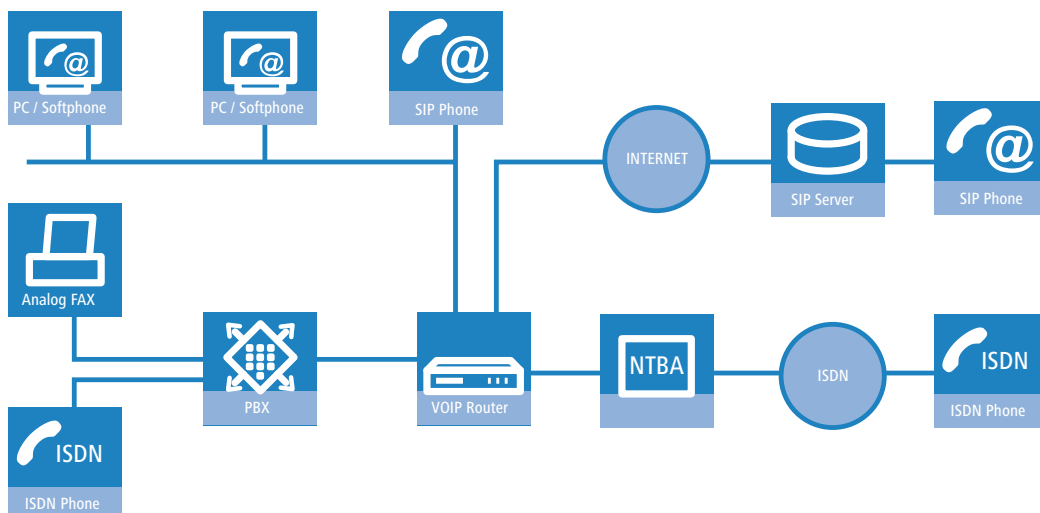

Telephone calls over the PBX and its ISDN telephones remain possible just as before; the telephones remain available under the familiar telephone numbers. This application additionally offers the following options:

- In addition to the ISDN telephones, VoIP telephones or VoIP softphones can be included in the telephone infrastructure. VoIP subscribers in the internal LAN are also able to call external ISDN subscribers.

- The ISDN telephones continue to function, and additionally they can call all of the internal VoIP telephones and softphones in the LAN.
- Calls to external SIP subscribers who use the same Internet provider are often available at no cost.
- With the appropriate connection to a public SIP provider, any other SIP subscriber worldwide can be called, irrespective of the provider network. As an alternative to a direct ISDN connection, ISDN network subscribers can also be reached over a diversion via the SIP provider. The costs depend on the provider's particular tariff models. Often, long-distance and overseas calls via a SIP provider are significantly cheaper than the traditional telephone connection.

In this constellation, the LANCOM VoIP router takes over the switching of the calls. The device can be individually configured, for example, to use the access codes to decide upon the switching of a call either via the ISDN interface, or via the Internet as a VoIP call.

Connecting subsidiaries or home offices to the headquarters

Many subsidiaries or home offices already have a connection to the network at headquarters over VPN. These connections are normally limited to conventional data transmission. By using VoIP, internal company calls can be made for free over the existing VPN connection and—thanks to the VPN encryption—these calls are secured against eavesdropping.

With a LANCOM VoIP router located in the branch or home office, the two worlds of POTS and VoIP telephony can be united in a single telephone: A VoIP telephone or an existing ISDN telephone can be used for free telephone calls via VPN to the headquarters, or to make standard calls via ISDN.

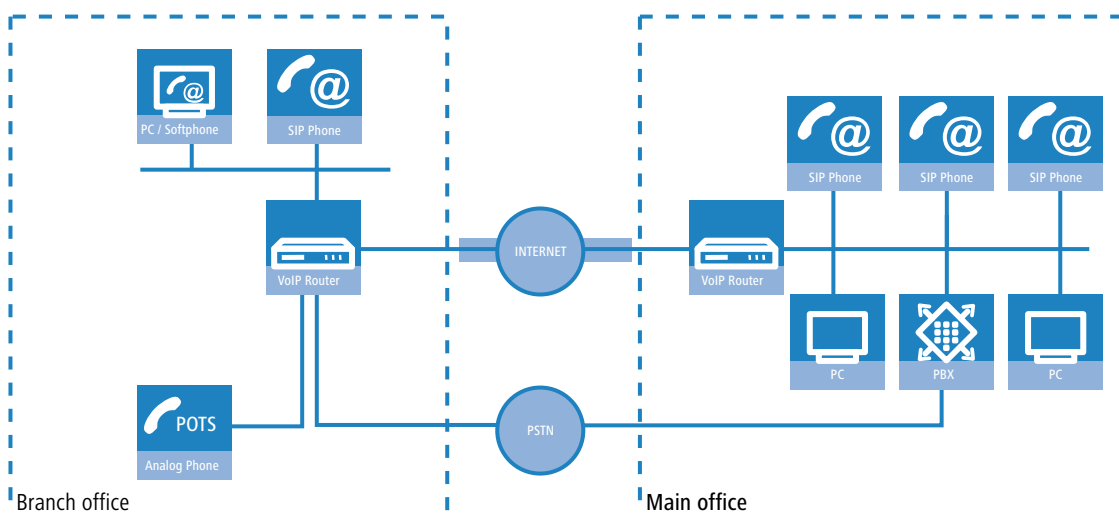

The advantages of a telephone connection to headquarters:

- The configuration of telephone functions can be carried out centrally in the VoIP PBX at headquarters.
- Subscribers at their branch or home offices connect with the central PBX.
- Calls within the company network are free.
- Outgoing calls are automatically directed to the best line for cost optimization.

VoIP for companies through SIP trunking

One of the biggest hurdles for companies that fully migrate to VoIP is to maintain the existing telephone numbers. Normal provider SIP accounts come with a telephone number for the transition to the landline telephone network, but generally these numbers are selected from a pool of numbers available to the provider. However, for companies with a large number of telephone subscribers and numbers, it is of decisive importance that existing telephone and extension numbers are maintained after migrating to VoIP.

With the SIP trunking function, entire ranges of telephone numbers made up of external numbers and their associated extensions can be mapped by LANCOM VoIP routers over a single connection to a SIP provider, assuming that the provider

also supports Direct Dialing In (DDI) and can provide multiple connections simultaneously. Generally speaking, SIP providers that offer SIP trunking can acquire the existing telephone numbers from the former telecoms provider.

Integrating local ISDN connections with remote SIP gateway

Companies with nation-wide and internationally distributed sites are often interconnected with VPN already. A LANCOM VoIP router can be used not only to connect the SIP and ISDN telephones at a branch office to the SIP-PBX at headquarters; it can also integrate local ISDN networks into corporate communications with help of the "SIP Gateway" function.

The SIP gateway is active for outgoing and incoming calls.

- A company headquarters in New York can, for example, use a LANCOM VoIP router with SIP gateway located at the Los Angeles branch office to telephone with customers and suppliers located in Los Angeles at local rates ("local break-out").
- For improved availability to customers located abroad, the New York headquarters can, for example, use a LANCOM VoIP router with SIP gateway located at their sales office in Italy. Customers can then reach support or service numbers via a standard national telephone number. Calls from the local ISDN network are received and directed within the company network to the appropriate employee. Call routing can be used which identifies the customer's calling number and automatically selects the appropriate connection to be used for forwarding the call.

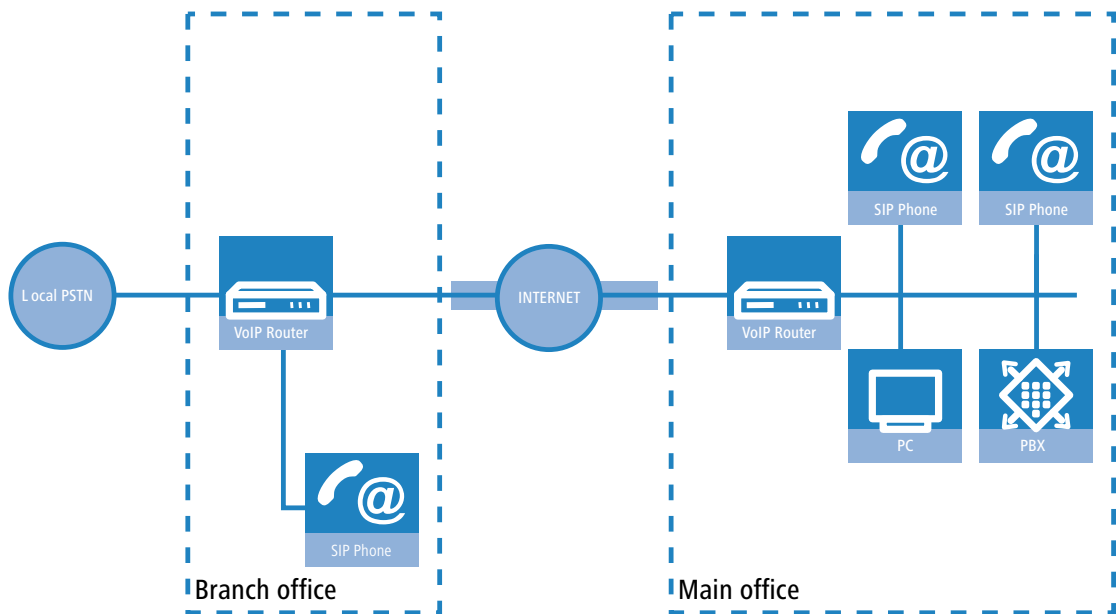

Advantages of the SIP gateway:

- The local ISDN connection at any site is available for use by any of the offices throughout the entire company.
- National and international long-distance calls can be mapped to local or regional calls, so saving costs.
- Automatic routing of incoming calls to the appropriate employee.

Connecting sites without a SIP PBX

Companies with widely dispersed offices and without their own SIP PBX can also take advantage of VoIP site-to-site connectivity. In this "Peer-to-Peer" scenario, a LANCOM VoIP router has been implemented at two locations.

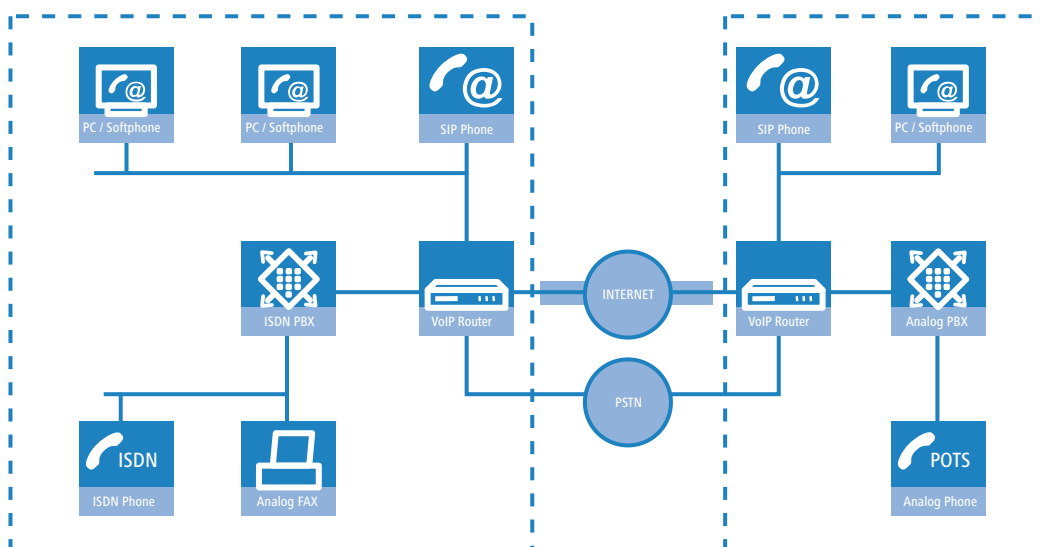

Along with data transfer via VPN, it is also possible to use VoIP functions between the two locations.

The advantages of peer-to-peer site connectivity

- > ISDN PBXs at different locations can form a common internal telephone network.
- > A SIP PBX is not necessary.
- > Calls within the company network are at no charge.
- > Outgoing calls are automatically directed to the best line for cost optimization.
- > Incoming calls can be switched directly to the appropriate employee at a different location.

1.2.2 The central position of the LANCOM VoIP router

LANCOM VoIP routers take up a central position in the switching of telephone calls between internal and external subscribers over the different channels of communication. Depending on the model and equipment, the devices interconnect the following communication participants and channels into a common telephone infrastructure.

1. Internal VoIP terminal devices connected to LAN, WLAN and DMZ, such as SIP telephones and SIP softphones
2. The internal ISDN infrastructure with ISDN PBX and ISDN telephones
3. Analog terminal devices, internally connected either into the ISDN network via a PBX with a/b ports, or alternatively into the VoIP network over an ATA (Analog Telephone Adapter).
4. External SIP providers and all of the external subscribers attainable through them
5. Upstream SIP PBXs with all of the internal and external subscribers reachable through them

6. The external ISDN world via ISDN NTBA or upstream ISDN PBX, and all of the external subscribers available via the land-line network

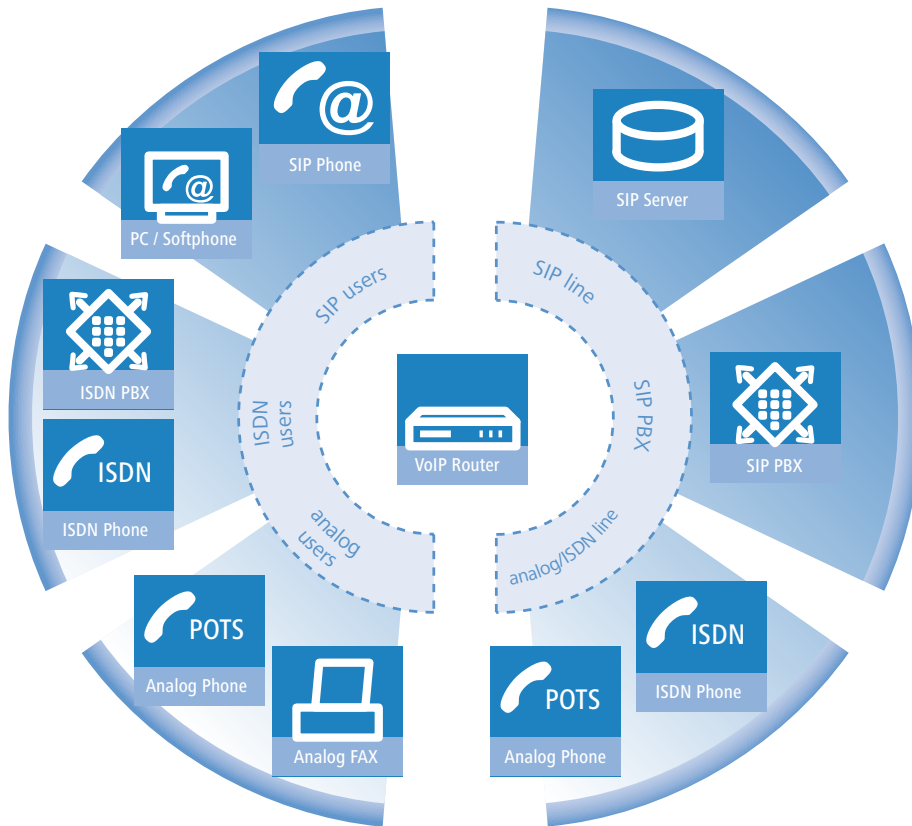

Users and lines

Telephony subscribers in internal areas can take part in voice communications and, in the LANCOM VoIP environment, are referred to as "users". The LANCOM differentiates between:

ISDN users

A maximum of 40 terminal devices connected over the ISDN network, including ISDN and analog devices connected to an upstream ISDN PBX.

When connecting downstream PBXs to point-to-point lines, the number of possible ISDN subscribers is determined by the length of the extension number (DDI). In this case, all of the telephones and terminal equipment connected to the PBX can be mapped with a single ISDN user entry.

SIP users

A maximum of 40 (with the LANCOM VoIP +10 option) SIP terminal devices connected over LAN and WLAN and analog devices connected with an ATA.

The external paths of communication available to the users are known as "lines". The LANCOM knows the following lines:

ISDN

A connection to an ISDN NTBA over the TE interface. The NT interface can additionally be used to connect ISDN terminal devices directly or via a downstream ISDN PBX.

SIP lines

A maximum of 55 lines (with VoIP +10 option) are possible. There are three different types of SIP line:

- A "Single account" line acts like a normal SIP account with a single telephone number. The internal users can all make use this account for making SIP calls, although only one call can be conducted at a time.

Depending on the provider services, these lines can be used to reach subscribers in the provider networks, subscribers in other SIP networks (partner networks), or even land-line subscribers. Your own availability at your own telephone number or even solely with a SIP name over the Internet also differs from provider to provider.

- A "trunk" line acts like an extended SIP account with a main external telephone number and multiple extension numbers. Internal users use this account in parallel and several calls can be made simultaneously (until the maximum available bandwidth is exhausted).
- As a "SIP gateway" line, the LANCOM VoIP router provides a remote SIP PBX with a transition to the local ISDN network. The SIP gateway is registered at the SIP PBX with a single number, although several calls can be conducted at once (until the maximum available bandwidth is exhausted). The connection between the SIP PBX and the LANCOM VoIP router is normally established over a VPN connection.

SIP PBX systems

Maximum 4 connections to upstream SIP PBXs. These lines are generally connections to large PBXs in the network at headquarters which can be reached via a VPN connection.



The precise number of users and lines available varies between models and software options.

1.3 Call switching: Call routing

All calls between internal subscribers and subscribers who can be reached over external lines are handled as SIP calls by the LANCOM—even if the connection is between two ISDN subscribers.

The call router in the LANCOM VoIP router handles the switching of the calls. The switching relies mainly on the information in two tables:

- For telephone numbers arriving at the call router, rules in the call-routing table are able to alter these numbers if needed and can decide which line to use for a call.
- The table for the locally registered user provides information about which terminal device is available at which internal telephone number.

The bandwidth reservation, QoS settings and firewall settings that are necessary for reliable transmission of voice data are carried out automatically by the LANCOM.

- When establishing a connection, the LANCOM checks (under consideration of the permitted codecs) the maximum bandwidth that will be required.
 - This bandwidth is then automatically reserved by the QoS module upon initiation of the connection.
 - If negotiation shows that the maximum bandwidth is not available, the connection will not be made.
 - If negotiations between the terminal devices can agree upon a codec with lower bandwidth requirements, then the reserved bandwidth will be reduced accordingly.
- All packets from ISDN users are given a DiffServ marking by the LANCOM (with SIP users, the QoS marking is usually handled by the telephones or softphones):
 - SIP packets for signaling are marked as CS1.
 - RTP packets are marked as EF.
- The ports required for the transmissions are activated automatically.

1.3.1 SIP proxy and SIP gateway

The tasks involved in switching calls between the different lines of SIP and ISDN subscribers are handled by two functions in the LANCOM VoIP router.

SIP proxy

A SIP proxy handles the switching between callers.

SIP gateway

The SIP gateway handles the conversion between IP-based telephony that uses the SIP protocol and other (telephone) networks, for example the ISDN network.

1.3.2 User registration at the SIP proxy

A LANCOM VoIP router represents the central exchange for SIP calls between different subscribers wanting to communicate over different types of line. The tasks of switching in the LANCOM are handled by the SIP proxy. A telephone signals the SIP proxy that it needs to establish a connection, and the SIP proxy uses certain rules to decide which line is to be used for the connection. Conversely, incoming calls are assigned to a certain terminal device by the SIP proxy according to its rules.

For terminal devices to be able to take part in this switching, they must be registered with the SIP proxy. Where the registration is limited to call switching by the LANCOM, we refer to "local registration".

If other exchanges are involved, e.g. an SIP PBX at another location, then we refer to an upstream registration. In this case, the LANCOM accepts the request for registration and forwards it upstream. In this instance, the LANCOM is described as "transparent proxy".

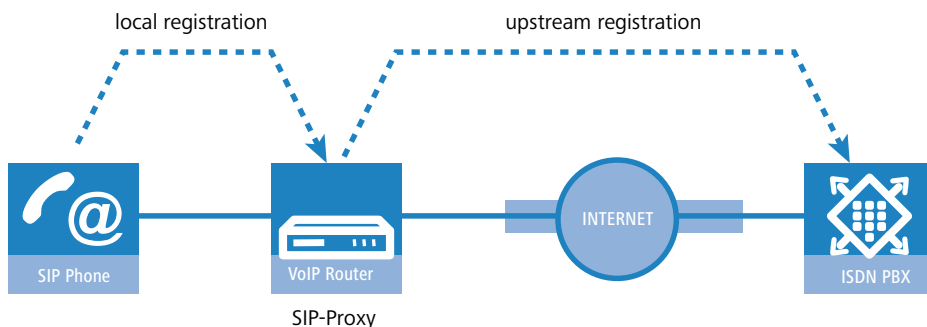

The great advantage with this two-stage registration comes to bear in the backup event: If the connection to an upstream SIP PBX is not available, the SIP proxy can handle the user who is registered upstream as a local user and can then direct the calls over alternative lines.

Registering at the LANCOM VoIP router (local registration)

For local registration at the LANCOM, the user just has to send a valid VoIP domain to the SIP proxy and has to be registered as a SIP user. Valid domains include the internal VoIP domains of the LANCOM VoIP router and all of the domains entered for a SIP line.

- For SIP terminal devices in the LAN (SIP telephone or SIP softphone), the domain is entered in the configuration.
- The domain cannot be entered into ISDN terminal equipment; instead, ISDN users have to be registered in the LANCOM configuration with a corresponding entry as an ISDN user.
- To prevent unknown subscribers from registering, authentication at the SIP proxy can be set as a prerequisite to local registration (local authentication). In this case, an entry as a SIP or ISDN user with corresponding password in the LANCOM VoIP router configuration is essential.

i Automatic registration without entering a password is restricted to the SIP users in the LAN. SIP users in the WAN require an appropriate user entry and authentication by password.

Registration at an upstream SIP PBX (upstream registration)

Generally, authentication by user and password is always required for registration at a SIP PBX. There are two possible ways of transmitting the authentication data to the SIP PBX:

- All SIP and ISDN users at the LANCOM VoIP router end use the same shared access information. In this case, only the VoIP domain for the SIP PBX and the appropriate user ID are entered into the SIP terminal device. For ISDN users, the VoIP domain of the SIP PBX is entered into the LANCOM as an ISDN user. The SIP proxy recognizes the request for registration at the upstream SIP PBX if the domain communicated from the client agrees with a domain entered for the SIP PBX line. The proxy then forwards the registration data together with the shared password to the SIP PBX.

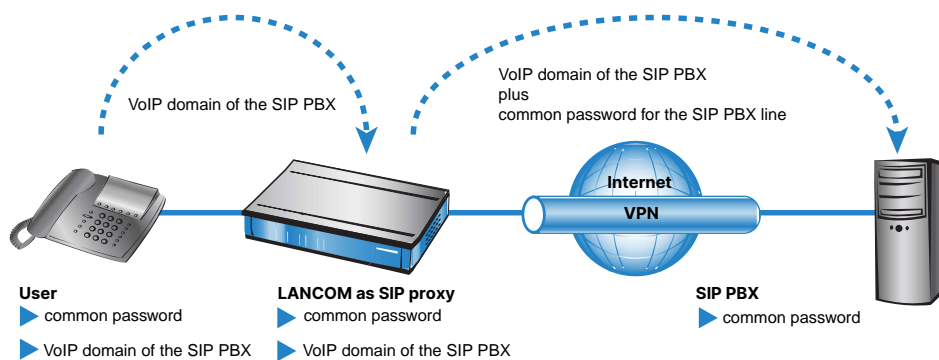

- If SIP or ISDN users at the LANCOM VoIP router are entered into the SIP PBX with different passwords, then the users have to enter their individual passwords upon registration. Consequently, each SIP or ISDN user has an entry in the

LANCOM with the individual passwords, which are also entered into the SIP terminal devices. Users with shared and individual passwords can be managed in parallel.

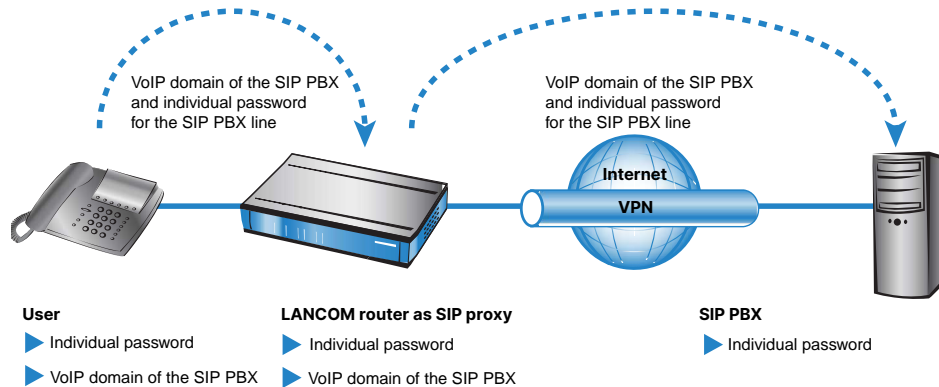

Particular aspects for ISDN users

Integrating ISDN terminal equipment into the LANCOM VoIP environment and the necessary steps for configuration depend upon the application at hand and, if applicable, upon the options available with a PBX. The main questions to be answered by the user are as follows:

- > Can ISDN terminal devices telephone internally with SIP users?
- > Are ISDN terminal devices available externally over SIP lines?
- > Can ISDN terminal devices telephone externally over SIP lines?

If ISDN terminal equipment can be reached over an ISDN TE interface on the LANCOM, it is described as "upstream". From the perspective of the LANCOM, the ISDN terminal devices are on an external line. This ISDN terminal equipment is normally not classified as being for local users, and so no entries for ISDN users are necessary.

ISDN terminal equipment at an upstream ISDN PBX...

- > can make internal calls to SIP users if the corresponding telephone numbers are configured as internal MSNs in the ISDN PBX.
- > can receive internal calls from SIP users if the internal MSNs of the ISDN equipment are output to the ISDN line by the call-routing table, for example over a standard route.
- > can only make calls over SIP lines if the PBX is able to output certain call numbers over its internal ISDN bus. Otherwise, all calls not matching with its internal MSNs would be forwarded by the ISDN PBX to the public telephone network.
- > can only receive calls from an upstream SIP PBX if entered into the LANCOM as an ISDN user and registered as such with the SIP PBX.

If ISDN terminal equipment can be reached over an ISDN NT interface on the LANCOM, it is described as "downstream". For the LANCOM, this is then a local subscriber that can be reached via the list of registered users. As ISDN terminal devices cannot send domain information to register at the LANCOM, this must be entered as an ISDN user so that it can be made known to the VoIP system.

ISDN terminal equipment at a downstream ISDN PBX...

- > can make internal calls to SIP users by entering the character for an outside line as required by the PBX and then dialing the SIP user's internal number. The PBX then forwards the call to the SIP user's internal number—without the outside-line access code—over its external ISDN bus to the LANCOM.
- > can receive internal calls from SIP users as long as the entry for the ISDN user contains the correct assignment of the internal number to the appropriate MSN. The LANCOM takes a call to the ISDN user's internal number, translates it to the MSN, and outputs it to the allocated ISDN bus. The PBX receives the MSN as if it were an external call and forwards it to the corresponding ISDN terminal equipment.
- > can conduct incoming and outgoing calls over SIP and ISDN just like SIP users. Again, the outside-line code may be necessary for outgoing calls.

Dynamic ISDN users at point-to-point connections

When connecting downstream PBXs to a point-to-point interface of the LANCOM VoIP router, the number of possible ISDN terminal devices is only limited by the length of the extension number. With three-figure extension numbers, almost 1000 terminal devices can be connected, all of which can be managed as ISDN users in the LANCOM VoIP router. Through an ISDN user entry with a # character as a placeholder for the telephone numbers, all ISDN terminal devices with their respective extension numbers can be set up as dynamic ISDN users.

 User entries that use # characters to map user groups cannot be used for registration at an upstream PBX. This registration always demands a specific entry for the individual ISDN user.

1.3.3 Number translation at network transitions

LANCOM VoIP routers switch calls between different telephone networks, e.g. the ISDN network, various SIP provider networks, and the internal telephone network. These networks generally have different ranges of numbers or even completely different conventions for addressing subscribers. Whereas the traditional land-line network uses numerical characters with country code and area access codes, the world of SIP allows alphanumerical names along with domain information.

The transition between these zones must guarantee the correct translation of "telephone numbers" so that the intended subscriber can be reached.

Depending on the application at hand, both the called and the calling numbers have to be modified in such a way that a call can be returned to the original caller.

Call number translation at the transition to outside lines is primarily implemented by mapping entries in the ISDN and SIP lines and by rules in the call-routing table.

1.3.4 The Call Manager

The Call Manager has the central task of allocating the calls waiting to be switched to a certain line or to a certain user. The Call Manager makes this allocation by using the call-routing table and the list of registered users. The calls are switched in the following steps:

> Processing of called numbers (Called Party ID)

First of all there is a check to see whether a numeric or alphanumeric number is available. Typical dialing separators such as "()-/" and <blank> are removed. A leading "+" is left in place. In this case, the number is still treated as a numeric number. If the check reveals any other alphanumerical character, the number is treated as alphanumeric and remains unchanged.

> Resolving the call in the call routing table

After processing the Called Party ID, the call is passed over to the call-routing table. Entries in the call-routing table consist of sets of conditions and instructions. The entries—with the exception of the default routes—are searched through and the first one that satisfies **all** of the conditions is executed.

> Resolution of the call with tables of local subscribers

If no entry is found in the call-routing table, then the Call Manager searches through the list of local subscribers. Call routing considers all of the users known to the call router (registered SIP users, configured ISDN users). If an entry is found that agrees with the called number and that has the matching destination domain, then the call is delivered to the corresponding subscriber.

If there is no local subscriber with matching number and destination domain, then the following cycle searches for an agreement between the number of the local subscriber and the called number; the destination domain is ignored.

> Resolution of the call with default entries in the call-routing table

If the preceding cycles referring to the call-routing table and lists of local subscribers remain unsuccessful, then the waiting call is checked once again with the call-routing table. This pass only takes the default routes into account, however. The numbers and destination domains entered into the default routes are ignored. Only the source filters are processed, assuming that the default route has these filters.

 Specific examples of call-routing procedures can be found in the configuration examples described.

1.3.5 Telephony with LANCOM VoIP routers

Using the LANCOM VoIP router opens up a variety of new possibilities for making telephone calls. Depending on the constellation of terminal equipment implemented (e.g. SIP or ISDN telephones, SIP or ISDN PBX systems) and depending on the configuration for call routing in the LANCOM VoIP router, certain information is critical for understanding the establishment of connections.

Automatic outside line access

Using the LANCOM VoIP router and the enhancement with VoIP functionality within your telephone structure is designed to support the users' telephone behavior with the greatest possible convenience. One of the core aspects of this is the use of "spontaneous" or "automatic" outside line access, a feature that is familiar to users of standard PBX systems.

- Most PBX systems are configured in such a way that the telephone subscribers must dial a "0" before the desired telephone number in order to gain access to an outside line - that is, to carry out a telephone conversation via a public telephone network.

Without the "0" prefix, the number dialed is considered to be an internal number from another extension line on the private PBX.

- If "automatic outside line access" is set up, all numbers dialed are directed over the public telephone network. In this case, internal telephone calls to other extensions are not possible or only possible when a special symbol is dialed before the number.

When the telephone structure is extended with a LANCOM VoIP router, a variety of new possibilities become available for connecting telephone terminal equipment. This includes the existing analog or ISDN telephones (where necessary, connected to the respective PBX) or VoIP terminal equipment such as SIP telephones or PCs with VoIP software.

As a new and central building block in the telephone structure, the LANCOM VoIP router assumes many of the PBX tasks for the terminal equipment connected to it. As such, you can also set up the automatic outside line access for the terminal equipment connected to the LANCOM VoIP router directly for the ISDN or SIP subscriber groups, thereby adapting it to existing telephone behavior.

- When automatic outside line access is turned off, subscribers must dial a "0" before the desired number in order to carry out a telephone conversation via a public telephone network.

All calls without a "0" preceding the number will be treated as calls to internal extensions within the private telephone network.

- If automatic outside line access is turned on, all numbers dialed will be directed over a public telephone network.

For telephone calls to internal extensions, a special symbol or a specific number combination must be dialed before the number. With the default settings, when automatic outside line access is enabled, a star * is activated as the identification symbol for an internal number. This setting can be adjusted to match the character that you are familiar with.

 If you operate the LANCOM VoIP router on the extension line of a PBX, we recommend that you configure outside line access for the router in the same way as for the PBX so that the behavior remains unchanged from the user's perspective.

Example of a downstream PBX

A LANCOM VoIP router is switched between the ISDN outside line and the existing ISDN PBX. In the PBX, automatic outside line access is enabled, the call router settings for the LANCOM VoIP router decide whether or not a "0" must be dialed for outside line access for the connected ISDN and SIP subscribers.

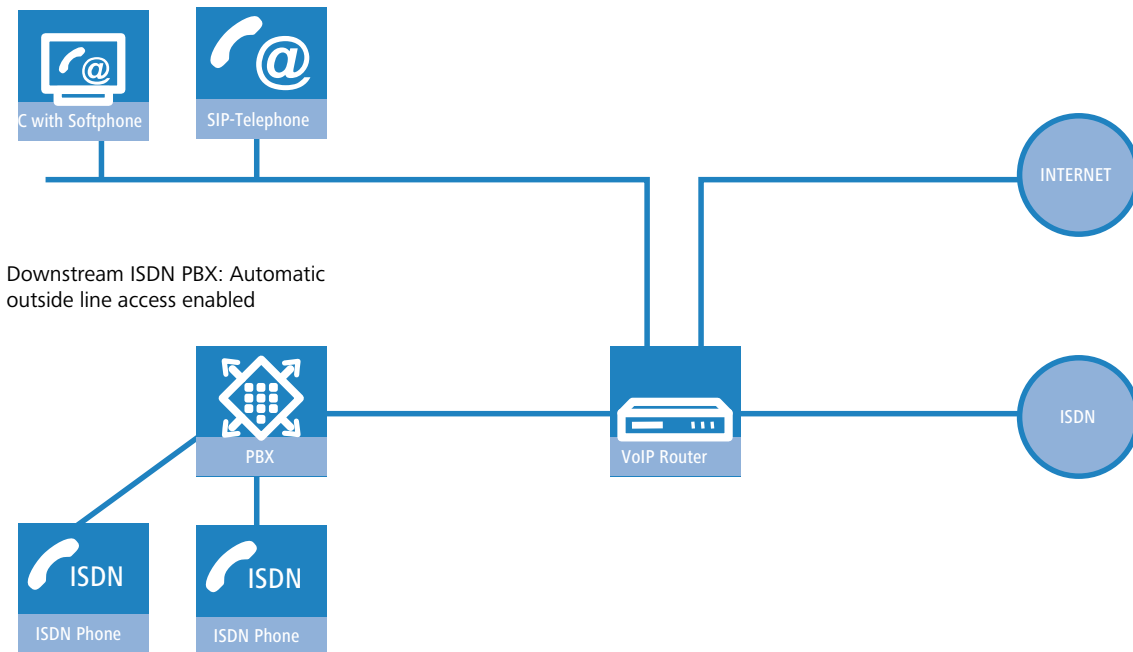

Example of an upstream PBX

A LANCOM VoIP router is connected to an ISDN PBX extension line. In the LANCOM VoIP router, automatic outside line access is enabled, and the settings for the upstream PBX decide whether or not a "0" must be dialed for outside line access for the connected ISDN and SIP subscribers.

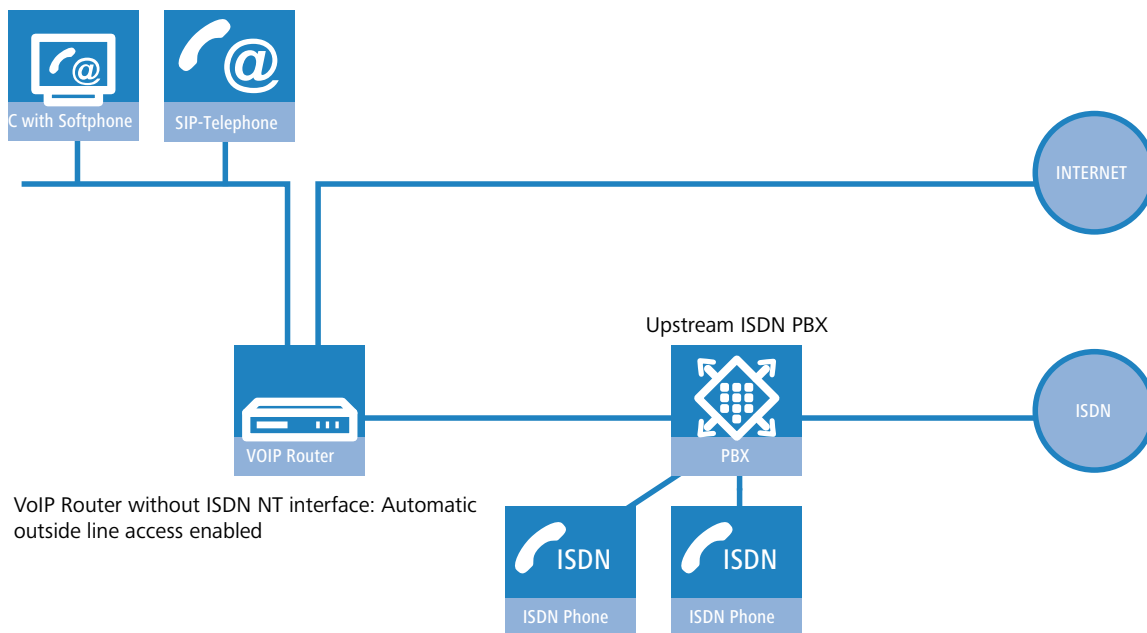

Dialing different number ranges

When dialing other parties, the following number ranges are available for use:

- Internal numbers are comparable to the extension numbers for traditional PBX systems. Subscribers can reach one another directly using these internal numbers without having to go through a public telephone network.

The internal numbers must be unique for all subscribers within the private telephone network, this also includes any other PBX systems that may be connected!

The internal subscribers can be reached by simply dialing the internal number without a "0" preceding it.

ⓘ Depending on the settings for automatic outside line access, a special preceding dialing signal may be required.

- Via **local telephone numbers** you can reach external parties who are in the same local telephone network as the LANCOM VoIP router, i.e. users with the same area code as the public line for the LANCOM VoIP router.

In decentralized locations that extend beyond city or state boundaries, the physical location of the device is decisive, even if a central PBX is located at a different location. Therefore, for a LANCOM VoIP router in London, all telephone subscribers in the local telephone network for London can be reached using local numbers, even if a SIP PBX connected via VPN can be reached in Manchester.

ⓘ Depending on the settings for automatic outside line access, a "0" prefix may be required.

- The **national and international numbers** behave in the same way as local numbers; here, the physical location of the devices is decisive for the assignment of corresponding access codes. Therefore, a LANCOM VoIP router in Austria belongs to the national telephone network in Austria, even if there is a VPN connection to the SIP PBX at the headquarters in Germany.

ⓘ Depending on the settings for automatic outside line access, a "0" prefix may be required.

Service numbers

Certain service numbers (emergency numbers, toll-free or expensive premium lines) can be subjected to special treatment by the call router.

- For example, this ensures that emergency numbers for the police or fire department are always reached, even if the subscribers do not dial the correct preceding dialing signal for outside line access.

With the default settings, the emergency numbers "110" and "112" are configured in such a way that they can be dialed correctly with or without the preceding "0".

- For toll-free numbers such as "0800", a direct connection via ISDN is usually selected in order to use the toll-free land-line to land-line connection.

Dialing via specific lines

The LANCOM VoIP router allows additional phone lines to be used for voice communication as a supplement to your existing ISDN exchange lines. These new lines may be to a SIP PBX connected via VPN, or to a public SIP provider on the Internet. Each time a connection is established, the call router uses pre-determined rules to decide which of the existing lines is to be used for the call.

As an alternative to the automatic selection by the call router, you can direct individual calls to a certain line, for example when you want to call a party purposely via ISDN and not via the SIP PBX at the headquarters. For this purpose, the call router assigns specific code numbers to existing lines, such as "98" for ISDN or "97" for a SIP provider. The targeted call via this line is then initiated with the corresponding identifier:

- The call with "020 123456" is assigned to a corresponding line by the call router, e.g. via the SIP PBX at the headquarters.
- However, the call with "98 020 123456" is made directly via the ISDN connection by the call router.

1.3.6 Hold call, swap call, transfer call

LANCOM VoIP routers support various services which are familiar to users of the ISDN network:

- With **call hold** the user can place an active call into a wait state. In this state the user can make a call to another person, for example.
- With **swap call**, the user can switch to and fro between two connections. The user is only connected with one caller at a time, while the other caller is put on hold.
- With **transfer call** the user switches an active call over to another call which is on hold. The two callers are then connected and the user is no longer involved in the call.

The services call hold, swap call and transfer call are available to all local SIP, ISDN and analog users, and also to subscribers at an upstream SIP PBX; however, they can only be initiated by a SIP user.

1.3.7 Transmission of DTMF tones

ISDN telephone networks introduced the possibility of transmitting information about which button was pushed on the telephone using DTMF tones (Dual Tone Multiple Frequency). With the help of DTMF tones, the telephone user can communicate with voice mailboxes and computer telephony systems, for example.

In VoIP applications, special mechanisms are required to assume the DTMF tone function. If, for example, during a telephone call, a button is pressed on a VoIP telephone or a VoIP softphone, this should trigger the same action as a call with an ISDN telephone.

Generally, DTMF tones are transmitted in VoIP applications in one of two ways:

- In-band describes the transmission of the DTMF tones in the same data stream in which the voice data are transferred. However, this procedure is relatively unreliable because the DTMF tones in the IP datastream can easily be mistaken for voice data, particularly when using compression codecs.
- Out-of-band describes the transmission of the DTMF tones in a stream that runs parallel to the actual voice data. Two standards are generally used for out-of-band transmission:
 - SIP INFO (RFC 2976)
 - RFC 2833 (RTP Payload for DTMF Digits)

Both variants can encapsulate information into the signaling data stream depending, for example, on the buttons pressed, their tone frequency, and the length of time the button was pressed. In addition, events that should be transmitted with DTMF tones can also be transmitted in cleartext in the SIP data.

Configuring DTMF signaling

When configuring the DTMF signaling, you specify which variant is used for the transmission of the DTMF tones under **Voice Call Manager > Lines > SIP lines**:

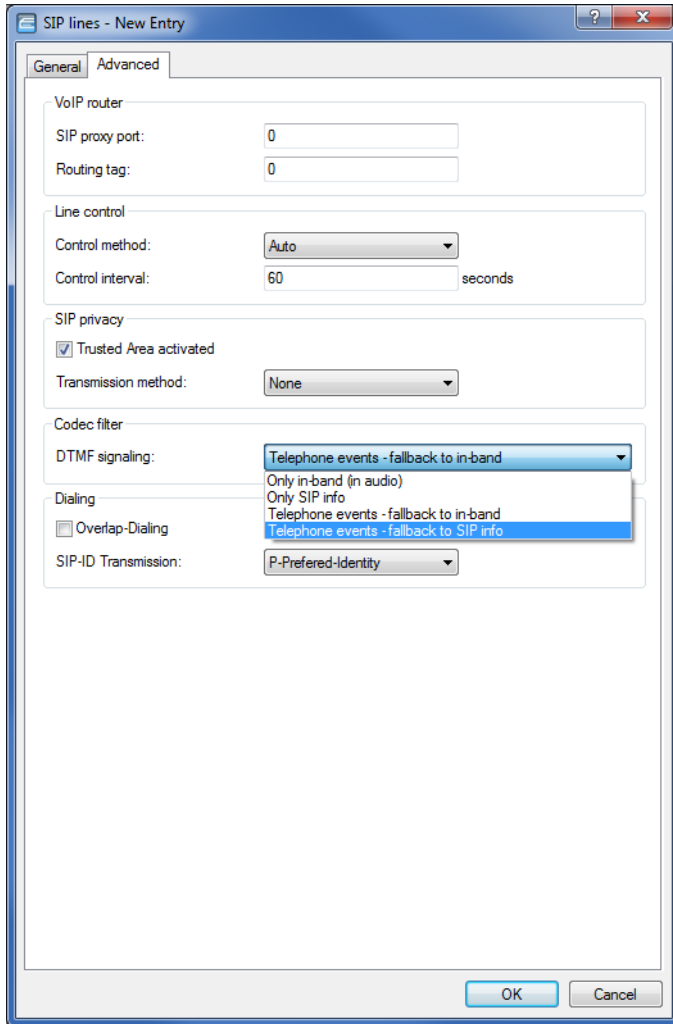

1.4 Configuring the VoIP parameters

1.4.1 General settings

To configure the settings for the general VoIP parameters, navigate to **Voice Call Manager > General**.

Voice Call Manager (VCM) enabled

Enables or disables the Voice Call Manager.

Local VoIP domain

Name of the domain in which the connected telephones and the LANCOM Wireless router are operated.

- Terminal devices working in the same domain register as local subscribers at the LANCOM Wireless router and make use of the SIP proxy.
- Terminal devices working with the other domain of an active SIP PBX line register themselves as subscribers at an upstream PBX.

Create a SYSLOG message for each call

Each time a call is made with the LANCOM VoIP router a SYSLOG message is created.

 Please consider that you can only use this feature with the proper SYSLOG settings.

Send an e-mail for each call

Each time a call is made with the LANCOM VoIP router an e-mail is sent to the defined address.

 Please consider that you can only use this feature if you have set up the appropriate SMTP account.

1.4.2 Line configuration

The parameters for the lines are configured under **Voice Call Manager > Lines**.

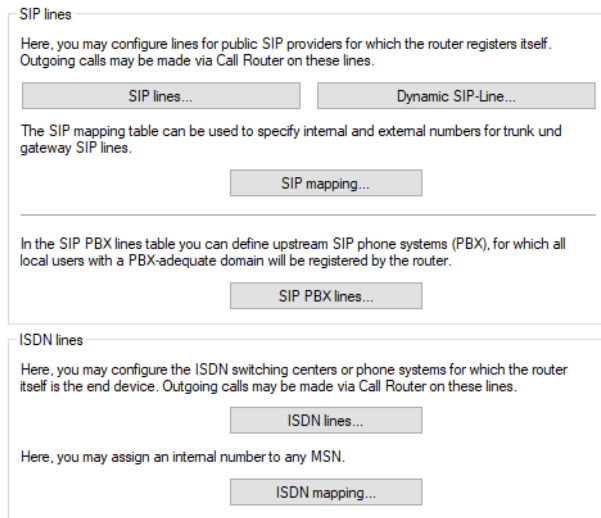

SIP lines

The device uses these lines to register with other SIP remote stations (usually SIP providers or remote gateways at SIP PBXs). The connection is made either over the Internet or a VPN tunnel.

The settings are configured under **Voice Call Manager > Lines** by clicking the button **SIP lines**.

The **General** tab contains the following configuration options:

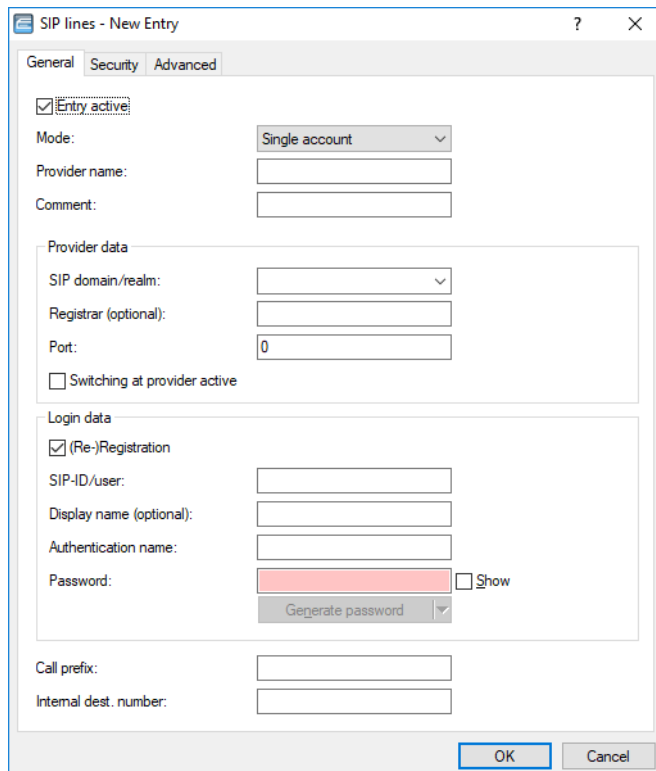

Entry active

Activates or deactivates this entry.

Mode

This selection specifies the operating mode of the SIP line. Possible values are:

Single account

Externally, the line behaves like a typical SIP account with a single public number. The number is registered with the service provider, the registration is refreshed at regular intervals (if (re-)registration has been activated for this SIP provider line). For outgoing calls, the calling-line number is replaced (masked) by the registered number. Incoming calls are sent to the configured internal destination number. The maximum number of simultaneous connections is either set by the provider or it depends on the available bandwidth and the codecs being used.

Trunk

Externally, the line acts like an extended SIP account with a main external telephone number and multiple extension numbers. The SIP ID is registered as the main switchboard number with the service provider and the registration is refreshed at regular intervals (if (re-)registration has been activated for this SIP provider line). For outgoing calls, the switchboard number acts as a prefix placed in front of each calling number (sender; SIP: "From:"). For incoming calls, the prefix is removed from the destination number (SIP: "To:"). The remaining digits are used as the internal extension number. In case of error (prefix not found, destination equals prefix) the call is forwarded to the internal destination number as configured. The maximum number of connections at any one time is limited only by the available bandwidth and possibly by the provider.

Gateway

Externally the line behaves like a typical SIP account with a single public number, the SIP ID. The number (SIP ID) is registered with the service provider and the registration is refreshed at regular intervals (if (re-)registration has been activated for this SIP provider line). For outgoing calls, the calling-line number (sender) is replaced (masked) by the registered number (SIP ID in SIP: "From:") and sent in a separate field (SIP: "Contact:"). For incoming calls the dialed number (destination) is not modified. The maximum number of connections at any one time is limited only by the available bandwidth and possibly by the provider.

Link

Externally, the line behaves like a typical SIP account with a single public number (SIP ID). The number is registered with the service provider, the registration is refreshed at regular intervals (if (re-)registration has been activated for this SIP provider line). For outgoing calls, the calling-line number (sender; SIP: "From:") is not modified. For incoming calls, the dialed number (destination; SIP: "To:") is not modified. The maximum number of connections at any one time is limited only by the available bandwidth and possibly by the provider.

Flex

- To the outside the line behaves like a commercially available SIP account with a single public number.
- The number is registered at the service provider and registration is refreshed on a regular basis.
- For outgoing calls, the calling-line number (sender) is not modified.
- For incoming calls the dialed number (destination) is not modified.
- The maximum number of connections at any one time is limited only by the available bandwidth.

Table for number translation:

Single account	SIP number incoming to the line	SIP number sent from the line
Outgoing call	"From:"	The number registered at the provider (User ID)
Incoming call	"To:"	User ID

Trunk	SIP number incoming to the line	SIP number sent from the line
Outgoing call	"From:"	Switchboard number (User-ID) + "From:"
Incoming call	Switchboard number (User-ID) + "To:"	"To:" as internal extension

Gateway	SIP number incoming to the line	SIP number sent from the line
Outgoing call	"From:"	The number registered at the provider (User ID)
	"From:"	"Contact:"
Incoming call	"To:"	"To:"

Link	SIP number incoming to the line	SIP number sent from the line
Outgoing call	"From:"	"From:"
Incoming call	"To:"	"To:"

Name

The name of the line: This may not be the same as another line (SIP provider, ISDN or SIP PBX) configured on the device.

Comment

Comment on this entry.

SIP domain/realm

SIP domain/realm of the upstream device. Provided the remote device supports DNS service records for SIP, this setting is sufficient to determine the proxy, outbound proxy, port and registrar automatically. This is generally the case for typical SIP provider services.

Registrar

The SIP registrar is the point at the SIP provider that accepts the login with the authentication data for this account.

 This field can remain empty unless the SIP provider specifies otherwise. The registrar is then determined by sending DNS SRV requests to the configured SIP domain/realm (this is often not the case for SIP services in a corporate network/VPN, i.e. the value must be explicitly set).

 To force SIP registration via IPv4 or IPv6 the SIP domain can be entered in the field **Registrar** followed by the suffix **?4** or **?6** (e.g. **SIP-Domain.com?4**).

Outbound proxy

The SIP provider's outbound proxy accepts all SIP-call signaling that originates from the device for the duration of the connection.

 This field can remain empty unless the SIP provider specifies otherwise. In this case, the outbound proxy is identical to the registrar. This is a typical configuration for SIP-provider offerings.

Port

This is the remote port used to communicate with the provider.

Switching at provider active

Call switching (transfer call) between two remote subscribers can be handled by the device itself (media proxy) or it can be passed on to the exchange at the provider if both subscribers can be reached on this SIP provider line. The advantage of this is that the LANCOM VoIP router no longer requires the bandwidth. Otherwise, the media proxy in the device switches the media flows, such as when connecting two SIP provider lines.

 Switching at the provider will only work if both connections are routed via the same provider line.

 An overview of the main SIP providers supporting this function is available in the Support area of our Internet site.

(Re-) registration

This activates the (repeated) registration of the SIP provider line. Registration can also be used for line monitoring.

 To use (re-) registration, set the line monitoring method on the **Advanced** tab to "Register" or "Automatic". The device renews its registration after the monitoring interval expires. If the provider's SIP registrar suggests a different interval, the devices uses this value automatically.

SIP-ID/user

Telephone number of the SIP account or name of the user (SIP URI).

 For a SIP trunking account, the switchboard number is entered here. For incoming calls, any numerals after the switchboard number are interpreted as extension numbers (DDI) and these are passed to the call router. For outgoing calls, DDI numbers received from the call router are combined with the switchboard number. This access data is used to register the line (single account, trunk, link, gateway), but not the individual local users with their individual registration details. If individual users (SIP, ISDN, analog) are to register with an upstream device using the data stored either there or on the terminal device, then a SIP-PBX line should be set up.

Display name

Name for display on the telephone being called.

 Normally this value should not be set as incoming calls have a display name set by the SIP provider, and outgoing calls are set with the local client or call source (which may be overwritten by the user settings for display name, if applicable). This settings is often used to transmit additional information (such as the original calling number when calls are forwarded) that may be useful for the person called. In the case of single-line SIP accounts, some providers require an entry that is identical to the display name defined in the registration details, or the SIP ID (e.g. T-Online). This access data is used to register the line (single account, trunk, link, gateway), but not the individual local users with their individual registration details. If individual users (SIP, ISDN, analog) are to register with an upstream device using the data stored either there or on the terminal device, then a SIP-PBX line should be set up.

Authentication name

Name for authentication to the upstream SIP device (provider/SIP PBX).

 This access data is used to register the line (single account, trunk, link, gateway), but not the individual local users with their individual registration details. If individual users (SIP, ISDN, analog) are to register with an upstream device using the data stored either there or on the terminal device, then a SIP-PBX line should be set up.

Password

The password for authentication at the SIP registrar and SIP proxy at the provider. For lines without (re-)registration, the password may be omitted under certain circumstances.

 This access data is used to register the line (single account, trunk, link, gateway), but not the individual local users with their individual registration details. If individual users (SIP, ISDN, analog) are to register with an upstream device using the data stored either there or on the terminal device, then a SIP-PBX line should be set up.

Call prefix

The device places a call-prefix number in front of the caller number (CLI; SIP "From:") for all incoming calls on this SIP line. This generates unique telephone numbers for return calls.

For example; you add a number here, which the call router analyzes (and subsequently removes) to select the line to be used for the return call.

Internal destination number

The effect of this field depends upon the mode set for the line:

- > If the line is set to "Single account" mode, all incoming calls on this line with this number as the destination (SIP: "To:") are transferred to the call router.
- > If the mode is set to "Trunk", the destination number is determined by removing the trunk's switchboard number. If an error occurs, the call will be supplemented with the number entered in this field (SIP: "To:") are transferred to the call router.
- > If mode is set to "Gateway" or "Link" the value entered in this field has no effect.

The **Security** tab contains the following configuration options:

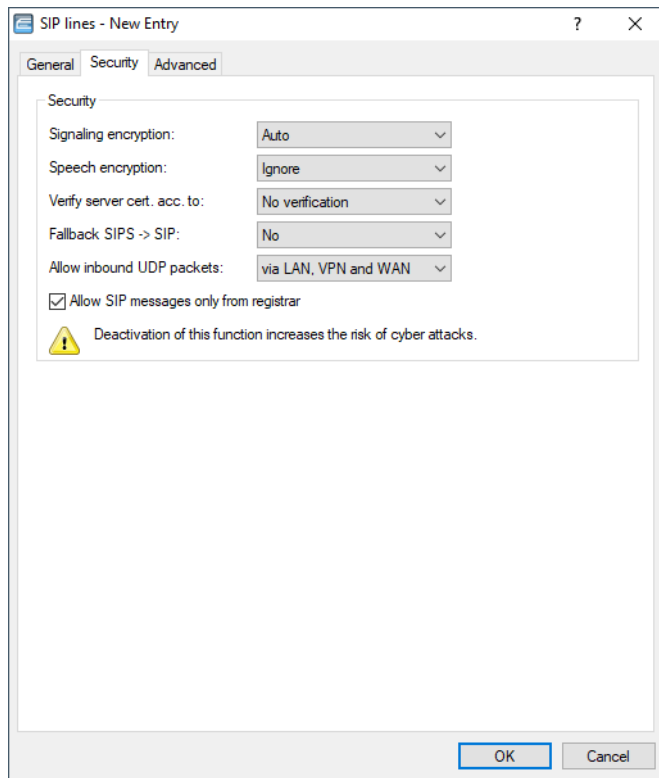

Signaling encryption

This setting determines the protocol used for signaling encryption (SIP/SIPS) for communications with the provider.

Automatic

NAPTR (Naming Address Pointer) records are used for DNS resolution. In the DNS data, the provider specifies the use of transport protocols such as UDP, TCP or TLS. The provider can also specify weights or priorities.

If TLS is specified as the transport protocol for signaling encryption by NAPTR, voice encryption is also used automatically, regardless of the explicit configuration setting of voice encryption.

No (UDP)

All SIP packets are transmitted connectionless. Most providers support this setting.

No (TCP)

All SIP packets are transmitted connection-oriented. The device establishes a TCP connection to the provider and maintains it for as long as it stays registered. Specialized providers, such as the providers of SIP trunks, support or force this setting.

TLS

Transmission is the same as with TCP, but all of the SIP packets are encrypted all the way to the provider. The TLS version selected in the configuration is taken as the minimum requirement for TLS encryption.

Speech encryption

This setting determines if and how the speech data (RTP/SRTP) is encrypted when communicating with the provider.

Speech encryption

Reject	Encryption is not available for outgoing calls. Incoming calls with an encryption proposal are rejected. The speech channel is not encrypted.
Ignore	Encryption is not available for outgoing calls. Incoming calls with an encryption proposal are accepted. The speech channel is not encrypted.
Prefer	Encryption is offered for outgoing calls. Incoming calls without an encryption proposal are accepted. The speech channel is only encrypted if the remote peer also supports encryption.
Force	Encryption is offered for outgoing calls. Incoming calls without an encryption proposal are rejected. The speech channel is either encrypted or is not established.

 If you require the encrypted transmission of speech data, the signaling must also use an encrypted channel. Please note that the use of SRTP is no guarantee of end-to-end encryption.

Verify server cert. acc. to:

With this setting, you specify whether the certificate of the SIP server is verified against certain Certificate Authorities (CAs). CA certificates from globally recognized certificate chains are updated with LCOS updates. They can also be manually updated by truststore updates.

Server certificate

No verification	The server certificate is not verified. All valid server certificates are accepted, whichever CA they were signed by. This setting is useful for accepting self-signed certificates.
All trusted CAs	The server certificate is verified against all CAs known to the device. These include all CAs that LCOS "knows" to be trusted and also those from the VoIP server certificate slots 1 to 3.
	<hr/>  The encrypted connection is only established if one of these certificates is validated successfully.
VoIP cert. slot 1	A check is made to see whether the server certificate was signed by the CA whose certificate was uploaded to slot 1 of the VoIP certificates.
VoIP cert. slot 2	A check is made to see whether the server certificate was signed by the CA whose certificate was uploaded to slot 2 of the VoIP certificates.

Server certificate

VoIP cert. slot 3 A check is made to see whether the server certificate was signed by the CA whose certificate was uploaded to slot 3 of the VoIP certificates.

Telekom-Shared-Business-CA4 With this setting, the device only accepts server certificates signed by the Telekom Shared Business CA4 CA.



Use this setting for SIP trunk connections from Deutsche Telekom.

Fallback SIPS > SIP**No**

No fallback to an unencrypted connection is performed. If it is not possible to establish an encrypted connection to the VoIP provider, the line remains unregistered.

UDP

As a rule, encrypted SIP connections are made with the TCP protocol and unencrypted connections are made with the UDP protocol. This setting switches directly to an unencrypted UDP connection if the encrypted TCP connection cannot be established.

Complete

If an encrypted TCP connection with the configured TLS version cannot be established, then attempts are made to establish an unencrypted TCP connection, and finally a UDP connection in order to register the VoIP line.



This setting provides the best compatibility, but may lead to a longer registration time.

Allow inbound UDP packets

If the provider line uses UDP to communicate with the registrar, it receives UDP packets on the desired local port. With this setting you specify the network context in which a UDP packet is accepted. The device only accepts a packet from the WAN / VPN / LAN if you have activated the corresponding setting. Otherwise the packet is dropped.

Allow SIP messages only from registrar (strict mode)

If this mode is activated, incoming SIP messages are only accepted from IP addresses that were reported by the provider when the domain / registrar was resolved.

If the VoIP provider signals a call from an IP address that was not included in the DNS resolution of the domain / registrar, the incoming call is not signaled to the internal subscriber.



Deactivating this function increases the risk of cyber attacks. SIP messages sent by an attacker can lead to calls being established and unwanted costs. SIP messages that are forwarded to internal clients can potentially exploit security vulnerabilities in the terminal devices.

On the tab **Advanced** you configure the SIP proxy, the line monitoring, and the calling line identification restriction.

SIP proxy port

This is the local port used by the SIP-proxy device to communicate with the remote station.

By default "0" is set here. The port is dynamically selected from the pool of available port numbers. You can also specify of a port in the range of "1" to "65535".

Routing tag

This routing tag selects a certain route in the routing table for connections to this SIP server.

Source address

The device automatically determines the correct source IP address for the destination network. To use a fixed source IP address instead, enter it symbolically or directly here.

Control method

Specifies the line monitoring method. Line monitoring checks if a SIP provider line is available. The Call Router can make use of the monitoring status to initiate a change to a backup line. The monitoring method sets the way in which the status is checked. Possible values are:

Automatic

The method is set automatically (default).

Deactivated

No monitoring. The line is reported as available when the option (re)registration is disabled. Otherwise it will be considered to be available only after a successful registration. This setting does not allow the actual line availability to be monitored.

Register

Monitoring by means of register requests during the registration process. This setting also requires **(Re-)registration** to be activated for this line.

Options

Monitoring via Options Requests. This involves regular polling of the remote station. Depending on the response the line is considered to be available or unavailable. This setting is well suited, for example, for lines without registration.

Monitoring interval

The monitoring interval in seconds. This value affects the line monitoring with option request. The monitoring interval must be set to at least 60 seconds. This defines the time period that passes before the monitoring method is used again.

Trusted area activated

Specifies the remote station on this line (provider) as "Trusted Area". In this trusted area, the caller ID is not concealed from the caller, even if this is requested by the settings on the line (CLIR) or in the device. In the event of a connection over a trusted line, the Caller ID is first transmitted in accordance with the selected privacy policy and is only removed in the final exchange before the remote subscriber. This means, for example, that Caller ID can be used for billing purposes within the trusted area. This function is interesting for providers using a VoIP router to extend their own managed networks all the way to the connection for the VoIP equipment.



Please note that not all providers support this function.

Transmission method

Specifies the method used for transmitting the caller ID in the separate SIP-header field. Possible values are:

None

The default setting, so no transmission takes place.

RFC3325

Transmission according to "P-Preferred-Id/P-Asserted-Id".

IETF-Draft-Sip-Privacy-04

Transmission according to "IETF-Draft-Sip-Privacy-04" by means of RPID (Remote Party ID).

DTMF signaling

Depending on the requirements, it may not be sufficient to transmit "inband" DTMF tones if a SIP receiver cannot recognize these. In this case, it is possible to configure an alternative method of DTMF transmission for All-IP connections.

Only in-band (in audio)

The tones are transmitted as DTMF tones (G.711) in the RTP (voice) stream.

Only SIP info

The DTMF tones are transmitted "out-of-band" as a SIP-info message with the parameters `Signal` and `Duration` (as per RFC 2976). There is no parallel transmission of G.711 tones.

Telephone events – fallback to in-band (default)

The DTMF tones are transmitted as specially marked events within the RTP stream (as per RFC 4733). There is no parallel transmission of G.711 tones.

If the call-initialization SDP message does not include `telephone-event` signaling, negotiations fallback to inband transfer as per G.711.

Telephone events – fallback to SIP info

The DTMF tones are transmitted as specially marked events within the RTP stream (as per RFC 4733). There is no parallel transmission of G.711 tones.

If the call-initialization SDP message does not include `telephone-event` signaling, negotiations fallback to transfer as per SIP-Info message.

Overlap dialing

Overlap dialing significantly reduces the waiting time between the number being dialed and the call being established.

With overlap dialing disabled, your LANCOM device uses an overlap timer. The factory setting for this is 6 seconds. If the timer expires without you dialing any further numbers, the number entered so far is considered to be complete and the call is established.

With overlap dialing enabled on the line, portions of the dialed number are immediately sent to the All-IP provider.

If the All-IP provider responds with "484 number incomplete", the Voice Call Manager collects any additional dialed digits and sends them to the exchange again.

In this way, calls are established as quickly as possible without the 6 second delay, as you are accustomed to from your ISDN connection.



However, since this functionality is not supported by all SIP providers, overlap dialing has to be configured for each individual SIP line.

Call forwarding using SIP 302

Activates call forwarding via SIP 302 at the SIP provider. See also [Call forwarding \(call deflection / partial rerouting\) at the SIP trunk \(SIP 302\)](#) on page 70.

SIP-ID transmission

This field sets the way in which the SIP ID is transmitted for outgoing calls when operating a SIP trunk. Depending on the provider, it may be necessary to transmit the SIP ID via a different field, as otherwise the call might be rejected by the provider.

The following values can be selected:

- > P-Preferred-Identity (default value)
- > FROM
- > None
- > P-Preferred-Identity without DDI
- > PPI-PPI
- > None – PPI (P-Preferred-Identity)
- > None – PAI (P-Asserted-Identity)

Selecting the option **P-Preferred-Identity** (PAI- PPI) transmits the SIP ID including the DDI via the PPI/ PAI. The source telephone number is transmitted via the FROM field.

Selecting the option **FROM** transmits the SIP ID via the FROM field. The source telephone number is transmitted via the PPI / PAI field.

With the setting **None**, the SIP ID is not transmitted. The first calling number is transmitted with FROM, the second in the PPI / PAI.

In contrast to the P-Preferred-Identity, the setting **P-Preferred-Identity without DDI** does not transmit an extension number (DDI) in the SIP ID via the PPI.

Selecting the option **PPI- PPI** (PPI) transmits the SIP ID including the DDI via the PPI. The source telephone number is transmitted via the FROM field.

With the setting **None – PPI (P-Preferred-Identity)**, the SIP ID is not transmitted. The first calling number is transmitted with FROM, the second in the PPI.

With the setting **None – PAI (P-Asserted-Identity)**, the SIP ID is not transmitted. The first calling number is transmitted with FROM, the second in the PAI.

 With a single account, outgoing calls always signal the SIP ID in the **FROM** field.

Dynamic SIP lines

The settings are configured under **Voice Call Manager > Lines** by clicking the button **Dynamic SIP line**.

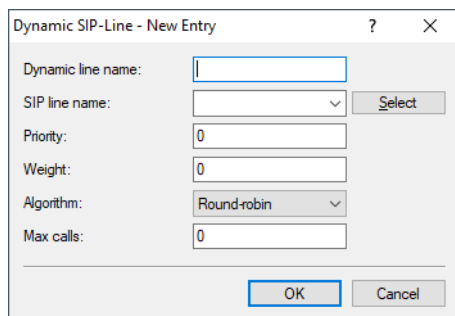

Dynamic line name

Enter the name for the dynamic line here. If the dynamic line consists of several physical lines, you can also use this dynamic line name for other table entries. This dynamic line name can later be used in the call routing table as the destination line.

SIP line name

Here you select one of the already configured physical SIP connections.

Priority

Here you specify the priority of the physical line for consideration when outgoing calls are distributed.

Weight

Here you specify the weighting of the physical line for consideration when outgoing calls are distributed.

Algorithm

The algorithm must be configured identically for all entries that belong to a dynamic line. The following algorithms can be used:

Weight

This algorithm controls the percentage of calls being distributed between different physical lines.

Round-Robin

With this algorithm, outgoing calls are distributed sequentially to the physical lines.

Priority

The physical line with the highest priority is fully utilized first, before the physical line with the next-lowest priority is used.

Max. calls

Here you enter how many simultaneous voice channels can be used on the physical SIP line. For no restriction on the number of voice channels, enter 0 here.

SIP mapping

The entries made under SIP mapping establish a series of rules for number translation to SIP lines in the trunk or gateway mode.

- A SIP line in trunk mode is used for mediating between internal numbers and the range of telephone numbers offered by a SIP account.
 - For incoming calls, the destination number (called party ID) is modified. The internal number is used if the called party ID matches with the external telephone number.
 - For outgoing calls, the calling party ID is modified. The external number is used if the calling party ID matches with the internal telephone number.

 For SIP mapping on trunk lines, only the extension (DDI) is mapped. The extension is interpreted as those numerals which follow the switchboard number (SIP ID or SIP line).

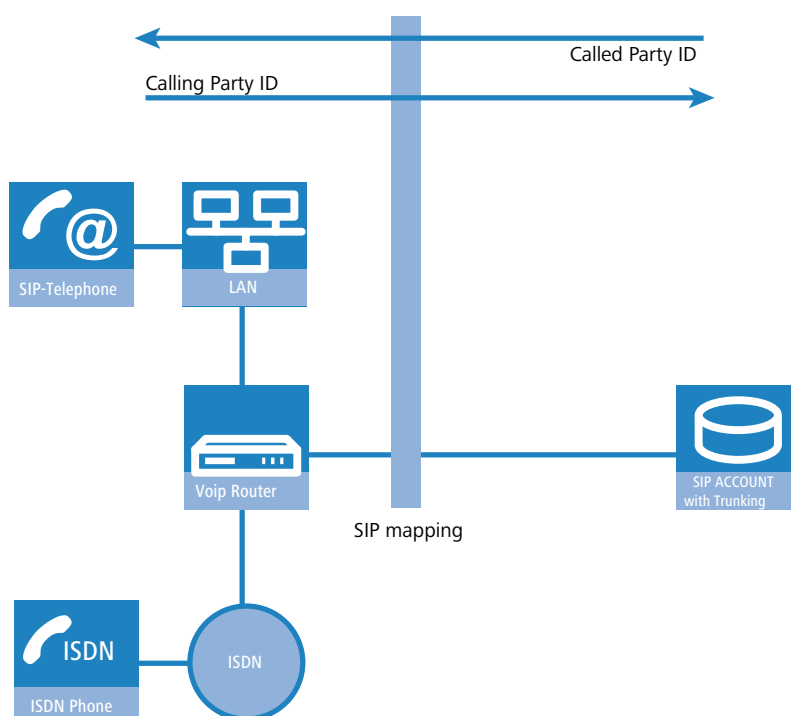

- For a SIP line in gateway mode, the telephone number plan of the upstream SIP PBX is adapted to the internal numbers in the call router.
 - For incoming calls (from the SIP line), the calling party ID is modified. The internal number is used if the calling party ID matches with the external telephone number.

- For outgoing calls (to the upstream PBX), the destination number (called party ID) is modified. The external number is used if the called party ID matches with the internal telephone number.

i For SIP mapping to gateway lines, the full telephone number is mapped. Depending on the configuration, the call number arriving at the ISDN interface can be subjected to further mapping (ISDN mapping).

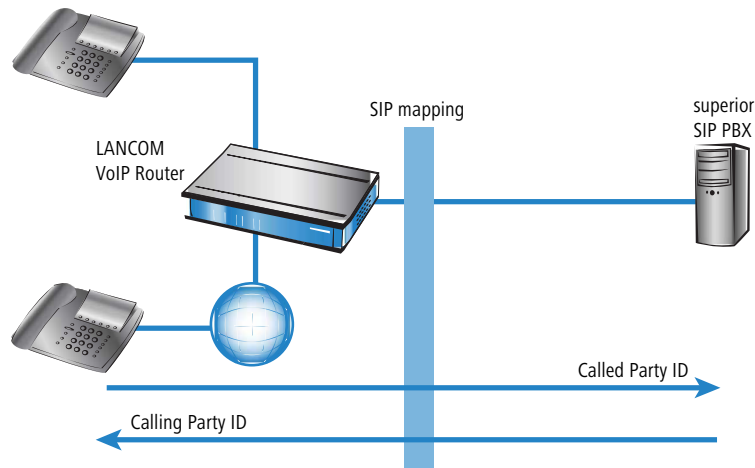

SIP mapping is configured under **Voice Call Manager > Lines** by clicking the button **SIP mapping**.

The screenshot shows the 'SIP mapping - New Entry' configuration window. It includes the following fields and options:

- Entry active
- Trunk/gateway name: [Dropdown menu] [Select]
- Comment: [Text input field]
- Outgoing calls:
 - External number/name: [Text input field]
 - Length of called number: 0 [Text input field] digits
- Incoming calls:
 - Internal dest. number: [Text input field]
- Buttons: OK, Cancel

Entry active

Activates or deactivates this entry.

Trunk/gateway name

Name of the line which is the destination of the call number mapping.

Comment

Comment about this rule.

External number / name

Call number within the range of those used by the SIP trunk account or upstream SIP PBX.

Length of called number

This value defines the number of numerals required for a called number to be regarded as complete. It only applies to SIP gateway lines with entries that end in a # symbol.

For an outgoing call, the external called number generated from this entry is automatically regarded as complete according to the defined number of numerals, and then forwarded. This process speeds up the dialing process. Alternatively, the called number is regarded as complete when:

- > The user concludes the dialed number with a # symbol, or
- > a precisely matching entry was found in the SIP mapping table without a # symbol, or
- > the wait time expires.

 By setting the length of called number to '0' you deactivate the premature dialing of the called number based on its length.

Internal destination number

Telephone number in the range of the VoIP router.

 Using the # symbol as a placeholder allows blocks of numbers to be captured by one rule.

SIP PBX lines

These lines are used by the device to connect to upstream SIP PBXs. Connections are usually directed via VPN.

The settings are configured under **Voice Call Manager > Lines** by clicking the button **SIP PBX lines**.

The **General** tab contains the following configuration options:

Entry active

Activates or deactivates this entry.

SIP PBX name

Name of the line. This may not be the same as any other line (ISDN or SIP provider, or SIP PBX) configured on the device.

Comment

Comment on this entry.

(Re-) registration

This activates the (repeated) registration of the SIP PBX line. With (re-)registration activated, it is also possible to operate line monitoring.

 To use (re-) registration, set the line monitoring method on the **Advanced** tab to "Register". The device renews its registration after the monitoring interval expires. If the SIP registrar of the SIP PBX suggests a different interval, the devices uses this value automatically.

SIP domain/realm

SIP domain/realm of the upstream SIP PBX.

Registrar (optional):

The SIP registrar is the point that accepts the login with the configured authentication data for this account in the SIP PBX.

Outbound proxy (optional)

Port

Port of the upstream SIP PBX to which the device sends the SIP packets.

 Make sure that you activate this port in the firewall in order for the connection to work.

Default password

Shared password for registering with the SIP PBX. This password is required under the following circumstances:

- When SIP subscribers should be able to register at the PBX even without their own SIP credentials in the SIP user table of the device;
- When SIP users are able to register at the device without a password (no local authentication) but have access to the upstream SIP PBX by means of the shared password. In this case, the domain of SIP users must match the domain of SIP PBX line.

Allow inbound UDP packets

If the provider line uses UDP to communicate with the registrar, it receives UDP packets on the desired local port. With this setting you specify the network context in which a UDP packet is accepted. The device only accepts a packet from the WAN / VPN / LAN if you have activated the corresponding setting. Otherwise the packet is dropped.

Allow SIP messages only from registrar

Enable this checkbox if you want to receive SIP messages only through the registrar.

SIP proxy port

This is the local port used by the device proxy to communicate with the upstream SIP PBX. If this is set to "0", the device expects packets from the SIP PBX to arrive at the local SIP UDP server port (5060).

 Packet assignment is made faster by configuring a fixed, unique local port and entering this as the destination port in the SIP PBX.

Routing tag

Routing tag for selecting a certain route in the routing table for connections to this SIP PBX.

Source address

The device automatically determines the correct source IP address for the destination network. If you want to use a fixed source IP address instead, enter it symbolically or directly here.

Call prefix

The device places a call-prefix number in front of the caller number (CLI; SIP "From:") for all incoming calls on this SIP PBX line. This generates unique telephone numbers for return calls.

For example; you add a number here, which the call router analyzes (and subsequently removes) to select the line to be used for the return call.

Line prefix

For outgoing calls on this line, the device inserts this prefix in front of the calling number in order to create a complete telephone number that is valid for this line. For incoming calls, the device removes this prefix, if applicable.

On the tab **Advanced** you configure the line monitoring, as well as the calling line identification restriction.

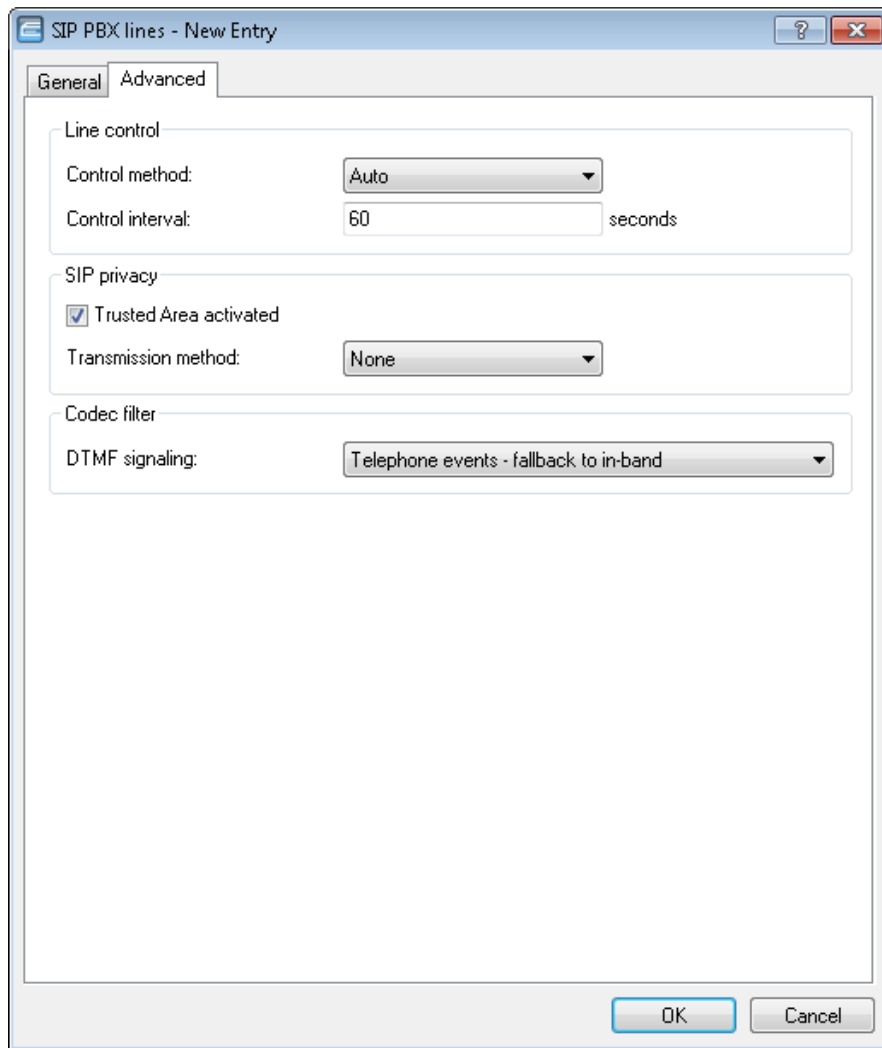

Control method

Specifies the line monitoring method. Line monitoring checks if a SIP PBX line is available. The Call Router can make use of the monitoring status to initiate a change to a backup line. The monitoring method sets the way in which the status is checked. Possible values are:

Automatic

The method is set automatically.

Deactivated

No monitoring. The line is always reported as being available. This setting does not allow the actual line availability to be monitored.

Register

Monitoring by means of register requests during the registration process. This setting also requires **(Re-)registration** to be activated for this line.

Options

Monitoring via Options Requests. This involves regular polling of the remote station. Depending on the response the line is considered to be available or unavailable. This setting is well suited for e.g. lines without registration.

Monitoring interval

The monitoring interval in seconds. This value affects the line monitoring with option request. The monitoring interval must be set to at least 60 seconds. This defines the time period that passes before the monitoring method is used again.

Trusted area activated

Specifies the remote station on this line (provider) as "Trusted Area". In this trusted area, the caller ID is not concealed from the caller, even if this is requested by the settings on the line (CLIR) or in the device. In the event of a connection over a trusted line, the Caller ID is first transmitted in accordance with the selected privacy policy and is only removed in the final exchange before the remote subscriber. This means, for example, that Caller ID can be used for billing purposes within the trusted area. This function is interesting for providers using a VoIP router to extend their own managed networks all the way to the connection for the VoIP equipment.



Please note that not all providers support this function.

Transmission method

Specifies the method used for transmitting the caller ID in the separate SIP-header field. Possible values are:

None

The default setting, so no transmission takes place.

RFC3325

Transmission according to "P-Preferred-Id/P-Asserted-Id".

IETF-Draft-Sip-Privacy-04

Transmission according to "IETF-Draft-Sip-Privacy-04" by means of RPID (Remote Party ID).

DTMF signaling

Depending on the requirements, it may not be sufficient to transmit "inband" DTMF tones if a SIP receiver cannot recognize these. In this case, it is possible to configure an alternative method of DTMF transmission for All-IP connections.

Only in-band (in audio)

The tones are transmitted as DTMF tones (G.711) in the RTP (voice) stream.

Only SIP info

The DTMF tones are transmitted "out-of-band" as a SIP-info message with the parameters `Signal` and `Duration` (as per RFC 2976). There is no parallel transmission of G.711 tones.

Telephone events - fallback to in-band (default)

The DTMF tones are transmitted as specially marked events within the RTP stream (as per RFC 4733). There is no parallel transmission of G.711 tones.

If the call-initialization SDP message does not include `telephone-event` signaling, negotiations fallback to inband transfer as per G.711.

Telephone events - fallback to SIP info

The DTMF tones are transmitted as specially marked events within the RTP stream (as per RFC 4733). There is no parallel transmission of G.711 tones.

If the call-initialization SDP message does not include `telephone-event` signaling, negotiations fallback to transfer as per SIP-Info message.

ISDN lines

The ISDN lines are configured under **Voice Call Manager > Lines** by clicking the button **ISDN lines**.

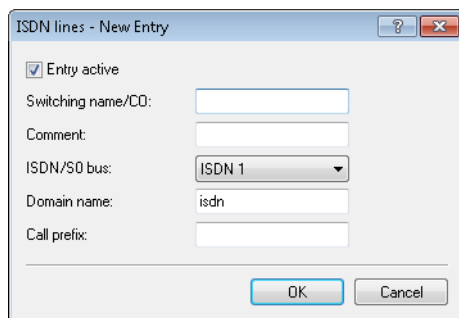

Entry active

Enables or disables the ISDN line.

Switching name/CO

Name of the line. May not be identical to another line that is configured in the device.

Comment

Comment on the line

ISDN/SO bus

ISDN interface(s) with which the device is connected to the ISDN network. The line entered here are usually configured as ISDN-TE.

Domain name

Domain of the "SIP world" used by the device to manage calls from and to the ISDN line.

Call prefix

The device places a call-prefix number in front of the caller number (CLI; SIP "From:") for all incoming calls on this ISDN line. This generates unique telephone numbers for return calls.

For example; you add a number here, which the call router analyzes (and subsequently removes) to select the line to be used for the return call.

ISDN mapping

With ISDN mapping, you assign external ISDN telephone numbers (MSN or DDI) to the telephone numbers that are used internally. To do this navigate to **Voice Call Manager > Lines** and click the button **ISDN mapping**.

Entry active

Enables or disables the external telephone number.

MSN/DDI

This line's external telephone number in the ISDN network.

The device forwards incoming calls for this MSN to the internal number configured below. For outgoing calls, the device replaces its own number with the MSN configured here.

- > MSN: Number of the telephone line
- > DDI (Direct Dialing in): Telephone extension number if the connection is configured as a point-to-point line.

! By using the # character as a placeholder, you can use a single entry to address entire groups of numbers, e.g. when using extension numbers

ISDN/SO bus

ISDN interface(s) used for connecting terminal devices to the device. These line have to be configured as ISDN-NT.

Comment

Comment on the external telephone number.

Internal Number

Internal telephone number of the ISDN telephone or name of the user (SIP URL).

For incoming calls, this is the SIP name or internal telephone number of the telephone to which the call from this interface is switched with the corresponding MSN/DDI. For outgoing calls, the SIP name is replaced by the MSN/DDI of the corresponding entry.

! By using the # character as a placeholder, you can use a single entry to address entire groups of numbers, e.g. when using extension numbers.

Hide your telephone number from the person being called (CLIR)

When enabled, the device does not reveal your telephone number to the called party.

1.4.3 Configuration of users

Local users are the terminal devices that are connected to the VoIP device. Users are categorized as follows:

SIP users

Users who are connected to the LAN by means of SIP. For the configuration of the user, it is unimportant if the LAN is accessed locally or via VPN (via the Internet). Along with SIP phones, you have also the option of setting up a SIP PBX as a user (internal SIP trunk connection).

ISDN users

Users who are connected by ISDN. These users use the SIP gateway to telephone using the VoIP function.

Analog users

Users who are connected via analog interfaces. These users use the SIP gateway to telephone using the VoIP function.

Users are configured with LANconfig under **Voice Call Manager > Users**.

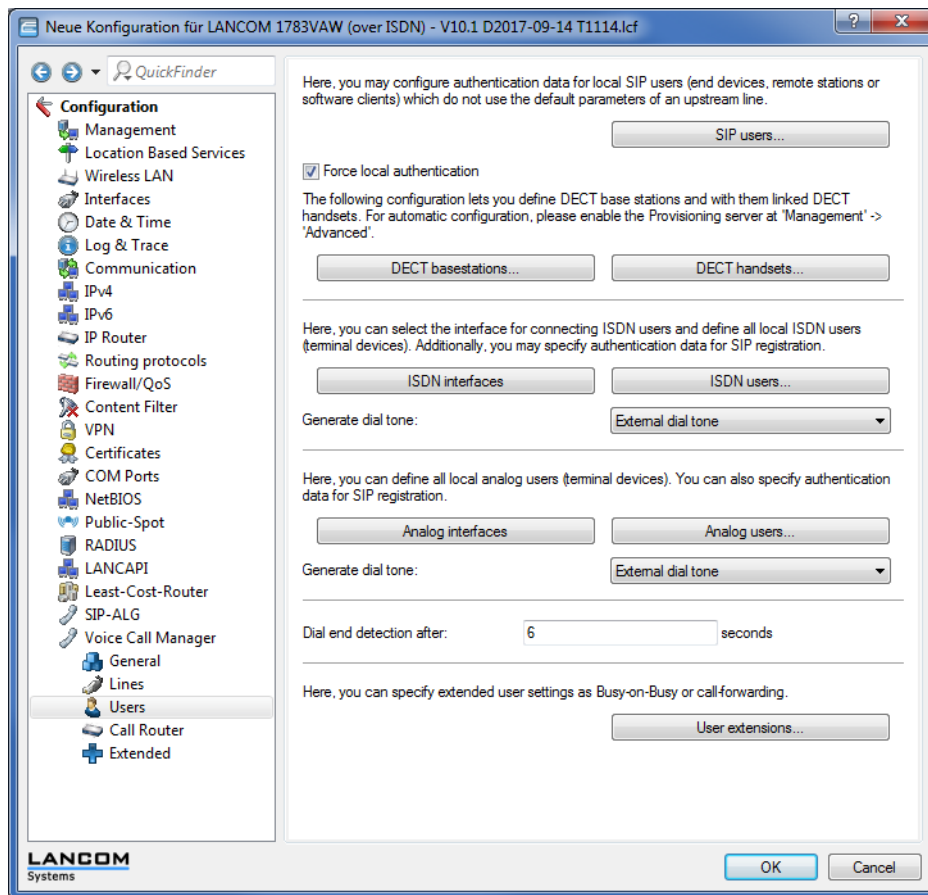

SIP users

The SIP proxy usually accepts a registration from all SIP users who register themselves with a valid domain and are known to the system as a SIP user. If under **Voice Call Manager > Users** in the section **SIP users** you enable the option **Force local authentication**, the only subscribers who can register at the SIP proxy are those stored in a user table with the appropriate access data.

i Automatic registration without entering a password is restricted to the SIP users in the LAN. SIP users from the WAN, as well as ISDN and analog users, are required to authenticate themselves by using the password in their corresponding user entry.

The button **SIP users** opens the dialog for configuring the authentication data of the SIP users (terminal equipment, remote stations or software clients) that do not use the default parameters of an upstream SIP PBX line.

Depending on the model you can create different numbers of SIP users, whereby identical names or identical numbers are not permitted.

Figure 1: Adding a new entry to the SIP user table

 The domain that is used by the SIP subscriber is usually configured in the terminal equipment itself.

Entry active

Activates or deactivates this entry.

Internal telephone number

- > Telephone number of the SIP phone
- > Name of the user (SIP URI)

- Switchboard number of the SIP PBX, followed by a #. Your SIP PBX must be in the same network as your device, either locally or connected via VPN (internal SIP trunk connection).

Comment

Comment about this SIP user.

Authentication name

Name for authentication at the SIP proxy, and also to any upstream SIP PBX when the user's domain is the same as the domain of a SIP PBX line. This name is required if registration is mandatory (e.g. when logging in to an upstream SIP PBX or when **Force local authentication** is set for local users).

Password

Password for authentication to the SIP proxy, and also to any upstream SIP PBX, when the user's domain is the same as the domain of a SIP PBX line. It is possible for users to log in to the local SIP proxy without authentication (**Force local authentication** is deactivated for SIP users) and where applicable to an upstream SIP PBX using a shared password (**Standard password** on the SIP PBX line).

Access from WAN

Permission for SIP users to authenticate via a WAN connection. Possible values are:

- Denied (default)
- Only via VPN

Device type

Specify what type of device is used by the SIP user.

Hide your telephone number from the person being called

Switches the transmission of the calling-line identifier on/off.

DTMF signaling

Depending on the requirements, it may not be sufficient to transmit “inband” DTMF tones if a SIP receiver cannot recognize these. In this case, it is possible to configure an alternative method of DTMF transmission for All-IP connections.

Only in-band (in audio)

The tones are transmitted as DTMF tones (G.711) in the RTP (voice) stream.

Only SIP info

The DTMF tones are transmitted “out-of-band” as a SIP-info message with the parameters `Signal` and `Duration` (as per RFC 2976). There is no parallel transmission of G.711 tones.

Telephone events - fallback to in-band (default)

The DTMF tones are transmitted as specially marked events within the RTP stream (as per RFC 4733). There is no parallel transmission of G.711 tones.

If the call-initialization SDP message does not include `telephone-event` signaling, negotiations fallback to inband transfer as per G.711.

Telephone events - fallback to SIP info

The DTMF tones are transmitted as specially marked events within the RTP stream (as per RFC 4733). There is no parallel transmission of G.711 tones.

If the call-initialization SDP message does not include `telephone-event` signaling, negotiations fallback to transfer as per SIP-Info message.

Msg. Waiting (MWI) via

The presence of voice messages left on your provider's online mailbox are signaled by notifications on the device. Signaling occurs in different ways depending on the terminal type. Select the line for which this function should be enabled from the list of configured SIP lines under **Voice Call Manager > Lines > SIP users**.



Notification only occurs if the provider supports this function.

Transport protocols

Select a protocol used by this user to communicate with the local SIP server. If the appropriate protocol is not selected, SIP requests from this user will be rejected with a SIP error response (SIP/406). This ensures that no users are able to register with a protocol that has not been allowed here.

UDP

All SIP packets to this SIP user are transmitted via connectionless UDP. Most SIP users support this setting.

TCP

All SIP packets to this SIP user are transmitted via connection-oriented TCP. The TCP connection is maintained for the duration of the registration.

TLS

All SIP packets to this SIP user are transmitted connection-oriented. Also, all SIP packets are encrypted.

Speech encryption

Use this entry to specify the protocol used to transmit the voice data (RTP/SRTP) of a call to the local SIP server.

Reject

There is no encryption proposal for calls by this user. Calls by this user with an encryption proposal are rejected. The voice channel is never encrypted.

Ignore

There is no encryption proposal for calls by this user. However, calls from this user with an encryption proposal are accepted. However, the voice channel is never encrypted.

Prefer

Calls by this user cause an encryption proposal. Calls from this user without an encryption proposal are also accepted. The voice channel is only encrypted if the user supports encryption.

Force

Calls by this user cause an encryption proposal. Calls by this user without a corresponding encryption proposal are ignored. The speech channel is either encrypted or is not established.



If you require the encrypted transmission of voice data, the signaling must also use an encrypted channel. Otherwise an attack on the unsecured signaling could potentially expose the key for the voice data. Please be aware that your provider may decrypt your voice data and re-transmit it newly encrypted or even unencrypted. The use of SRTP is no guarantee of end-to-end encryption.

SRTP cipher list

Here you specify the encryption method used for communication with the user. Select one or more of the following methods:

AES-CM-256

Encryption is performed using AES256. The key length is 256 bits.

AES-CM-128

Encryption is performed using AES128. The key length is 128 bits.

AES-CM-192

Encryption is performed using AES192. The key length is 192 bits.

F8-128

Encryption is performed using F8-128. The key length is 128 bits.

SRTP authentication

With this setting you restrict the amount of (proposed or accepted) SRTP suites that are negotiated with the corresponding user. If you do not select one or more of the ciphers shown below for encrypting the SRTP packets, the device will never propose the corresponding SRTP suite(s) and they are never selected. In this way you can force the best possible encryption.

HMAC-SHA1-80

SIP-user authentication is performed with the hash algorithm HMAC-SHA1-80. The hash length is 80 bits.

HMAC-SHA1-32

SIP-user authentication is performed with the hash algorithm HMAC-SHA1-32. The hash length is 32 bits.

General settings for all ISDN users

Under **Voice Call Manager > Users** you configure the general settings for all ISDN users in the section **ISDN users**.

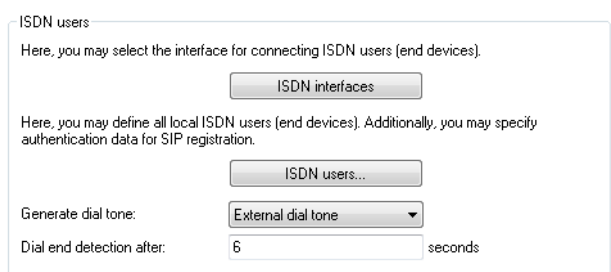



Generate dial tone

The dial tone determines the noise an ISDN user hears after lifting up the receiver. The "internal dial tone" is the same as the tone that a user hears at a PBX without spontaneous outside-line access (three short tones followed by a pause). The "external dial tone" is thus the same as the tone that indicates an external line when the receiver is lifted (constant tone without any interruptions). If necessary, adapt the dial tone for the users with spontaneous outside-line access to simulate the behavior of a standard outside line.

End dial detection after

During dialing, this is the time in seconds taken by the device to wait for further digits, after which it takes a number to be complete and sends it to SIP.

 If the entry is '0', ISDN users need to suffix the number with the '#' character.

 The '#' sign also services to shorten the delay configured here.

ISDN interfaces

Click on the **ISDN interfaces** button to adjust the global settings for the interfaces used by the ISDN users. An ISDN T interface (external) or even an ISDN TE interface (internal) can be configured. The latter is the case if users of an upstream PBX are to be managed as local users.

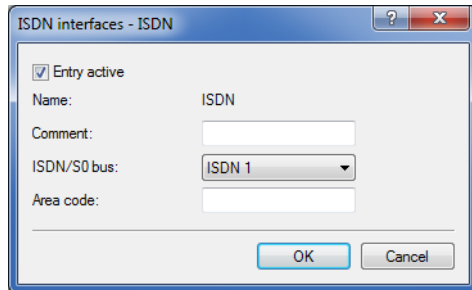

Entry active

Activates or deactivates this entry.

Name

Interface to which the ISDN subscribers are connected.

Comment

Comment on this entry.

ISDN/SO bus

Interfaces for the ISDN users to establish a connection.

ISDN users

The ISDN user settings are configured by clicking on the button **ISDN users**.

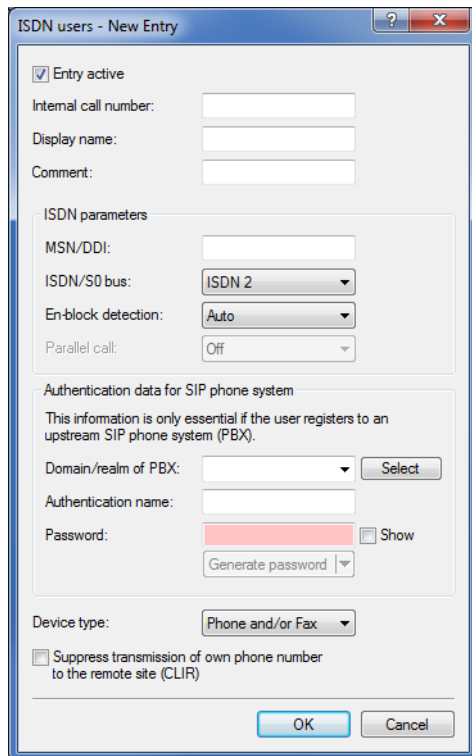

Entry active

Activates or deactivates this entry.

Internal telephone number

Internal number of the ISDN telephone or name of the user (SIP URI).

i By using the # character as a placeholder, you can use a single entry to address entire groups of numbers, e.g. when using extension numbers at a point-to-point connection.

i User entries that use # characters to map user groups cannot be used for registration at an upstream PBX. This registration always demands a specific entry for the individual ISDN user.

Display name

Name for display on the telephone being called.

Comment

Comment on this entry.

MSN/DDI

Internal MSN that is used for this user on the internal ISDN bus.

- > MSN: Number of the telephone connection if it is a point-to-multipoint connection.
- > DDI (Direct Dialing in): Telephone extension number if the connection is configured as a point-to-point line.

i By using the # character as a placeholder, you can use a single entry to address entire groups of numbers, e.g. when using extension numbers at a point-to-point connection.

 User entries that use # characters to map user groups cannot be used for registration at an upstream PBX. This registration always demands a specific entry for the individual ISDN user.

ISDN/SO bus

ISDN interface for the users to establish a connection.

En-bloc detection

With en-bloc dialing the device automatically detects that the dialed number is complete. A result of this is that the device places a call if it recognizes a group of digits as a contiguous block (e.g. for speed dialing). However, redialing is not an option.

Parallel call

If you use this feature, signaling occurs on all selected both ISDN lines. The call is accepted at the first telephone to pick up the call.

Domain/realm of PBX

Domain of an upstream SIP PBX when the ISDN user is to be logged in as a SIP user. The domain must be configured for a SIP PBX line in order for upstream login to be performed.

Authentication name

Name for authentication at any upstream SIP PBX when the user's domain is the same as the domain of a SIP PBX line.

Password

Password for authentication as a SIP user at any upstream SIP PBX when the user's domain is the same as the domain of a SIP PBX line. It is possible for ISDN users to log in to an upstream SIP PBX using a shared password (**Standard password** on the SIP PBX line).

Device type

Type of device connected.

Hide your telephone number from the person being called (CLIR)

Switches the transmission of the calling-line identifier on/off.

General settings for all analog users

LANconfig: **Voice Call Manager > Users**

Generate dial tone

The dial tone determines the noise an analog user hears after lifting up the receiver. The "internal dial tone" is the same as the tone that a user hears at a PBX without spontaneous outside-line access (three short tones followed by a pause). The "external dial tone" is thus the same as the tone that indicates an external line when the receiver is lifted (constant tone without any interruptions). If necessary, adapt the dial tone for the users with spontaneous outside-line access to simulate the behavior of a standard outside line.

Analog interfaces

The internal analog interfaces (a/b ports) require configuration if they are to be used by local users (connection of terminal equipment).

LANconfig: **Voice Call Manager > Users > Analog interfaces**

Interface

An internal interface to which the analog subscribers are connected.

Entry active

Interface is active / not active.

Analog users

LANconfig: **Voice Call Manager > Users > Analog Users**

Entry active

Activates or deactivates the entry.

Internal call number

Internal number of the analog telephone or name of the user (SIP URI).

Display name

Name for display on the telephone being called.

Comment

Comment on this entry.

Analog interfaces

Select the Analog interfaces which should be alerted when a call is made to the **Internal call number**.

Dial interfaces

Select an Analog interface. A telephone connected to this interface uses the **Internal call number** as a source number when it makes a call.

Suppress transmission of own phone number to the remote site (CLIR)

Switches the transmission of the calling-line identifier on/off.

Generate metering pulse

The metering pulse is used in analog telephone networks to inform callers of the costs of their calls. With appropriate terminal equipment (e.g. telephone with charge display), the metering pulse is filtered out from the overall signal and this information is converted to display the call charge.

 This option allows the metering pulse to be passed on to the analog user/equipment. It is possible for charge information from the ISDN telephone network to be transferred to an ISDN line and converted into an analog metering pulse.

Domain/realm of PBX

Domain of an upstream SIP PBX when the analog user is to be logged in as a SIP user. The domain must be configured for a SIP PBX line in order for upstream login to be performed.

Authentication name

Name for authentication at any upstream SIP PBX when the user's domain is the same as the domain of a SIP PBX line.

Password

Password for authentication as a SIP user to any upstream SIP PBX when the analog user's domain is the same as the domain of a SIP PBX line. It is possible for ISDN users to log in to an upstream SIP PBX using a shared password ("Standard password" on the SIP PBX line).

Device type

Type of device connected.

 The type determines whether an analog connection should be converted into SIP T.38, where applicable. Selecting "Fax" or "Telephone/Fax" activates fax signal recognition that could result in an impairment of the connection quality for telephones. Therefore please select the corresponding type of device connected in order to ensure optimum quality.

Extended user settings

Advanced user settings such as call waiting or call forwarding are configured here by clicking on the button **User extensions**.

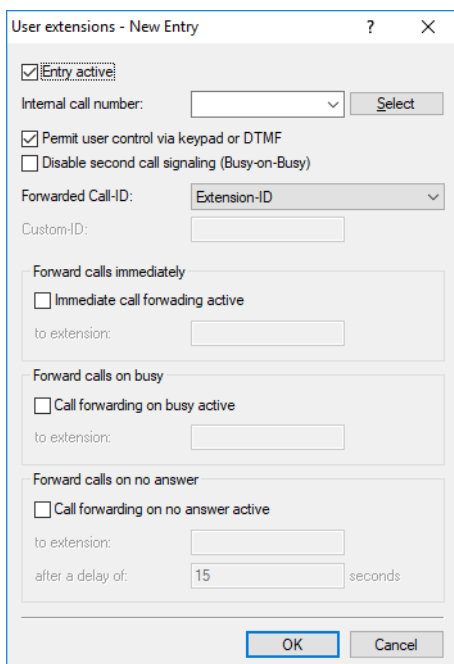

The screenshot shows a dialog box titled "User extensions - New Entry". It contains the following settings:

- Entry active
- Internal call number: [dropdown menu] [Select]
- Permit user control via keypad or DTMF
- Disable second call signaling (Busy-on-Busy)
- Forwarded Call-ID: [dropdown menu showing Extension-ID]
- Custom-ID: [text field]
- Forward calls immediately
 - Immediate call forwarding active
 - to extension: [text field]
- Forward calls on busy
 - Call forwarding on busy active
 - to extension: [text field]
- Forward calls on no answer
 - Call forwarding on no answer active
 - to extension: [text field]
 - after a delay of: 15 seconds

At the bottom, there are "OK" and "Cancel" buttons.

Entry active

Activates or deactivates this entry.

Internal telephone number

The call forwarding applies to this telephone number or SIP-ID.



Call forwarding can be set up for all local users (SIP, ISDN or analog).

Permit user control via keypad or DTMF

This activates or deactivates the option for users to configure their settings via the telephone.

Double second call signaling (Busy on busy)

Prevents a second call from being connected to a terminal device, irrespective of whether "CW" (call-waiting indication) is active on the device or not; i.e. there is no "call waiting" signal. The second caller hears an engaged tone. This also applies where an internal telephone number supports multiple logins and just one of the possible terminal devices is already in use.

Forwarded Call ID

Setting the signalled phone number. Possible values:

Extension ID

Signals the phone number that is forwarding the call.

Calling ID

Signals the incoming phone number. When forwarding to a mobile phone, a subscriber can recognize the original phone number of the calling subscriber.

Custom ID

Signals the phone number entered in the field **Custom ID**.

Call-forwarding unconditional (CFU)

Activates or deactivates the immediate forwarding of calls (CFU).

to extension

Destination for immediate unconditional call forwarding.

Forward calls on busy

Activates or deactivates call forwarding on "busy".

to extension

Destination for call forwarding on "busy".

Forward calls on no reply

Activates or deactivates the delayed forwarding of call (after waiting for no reply).

to number

Destination for call forwarding no reply.

After a delay of

Wait time for call forwarding on no reply. After this time period the call is forwarded to the destination number if the subscriber does not pick up the phone.

1.5 Call Manager Configuration

The Call Manager manages and connects the various subscribers and lines described above with one another. The Call Manager's main task is to determine the correct target subscriber for each call and to select a suitable line for this subscriber. To fulfill this task, the Call Manager mainly uses two table areas:

- The Call Routing table
- The tables of local subscribers

As the Call Manager usually switches between internal and external telephone networks with different number ranges, the Call Manager often has to modify the numbers that are dialed. This is known as number translation.

-
-  In the world of VoIP telephony it is possible to call numbers and names, such as "anyone@company.com". Although the following description refers to telephone numbers, this also includes telephone names unless specified otherwise.

The procedure known from internal extension lines is used, whereby connections to external subscribers start with a preceding '0'. The Call Manager processes calls to and from all registered subscribers and lines.

1.5.1 Process of call routing

The calls are switched in the following steps:

- Processing the calling number (Calling Party ID)

First of all there is a check to see whether a numeric or alphanumeric number is available. Typical dialing separators such as "()-/" and <blank> are removed. A leading "+" is left in place. In this case, the number is still treated as a numeric number. If the check reveals any other alphanumerical character, the number is treated as alphanumeric and remains unchanged.

- Resolving the call in the call routing table

After processing the Called Party ID, the call is passed over to the call-routing table. Entries in the call-routing table consist of sets of conditions and instructions. The entries are searched through and the first one that satisfies **all** of the conditions is executed.

- Resolution of the call with tables of local subscribers

If no entry is found in the call-routing table, then the Call Manager searches through the list of local subscribers. If an entry is found here matching the number that is called, and that also has the appropriate destination domain, then the call is delivered to the corresponding subscriber.

If no local subscriber is found for whom the number and destination domain match, another pass is made where it suffices for the telephone number of the local subscriber to match the called number; the destination domain is not considered.

- Resolution of the call with default entries in the call-routing table

If the previous passes through the call routing table and the lists with the local subscribers were unsuccessful, the call is checked again in the call routing table. This pass only takes the default routes into account, however. It does not include the numbers and destination domains that were entered in the default routes. Only the source filters are processed, assuming that the default route has these filters.

-
-  The procedure described here only considers the call numbers as processed by the Call Router. Mapping to the ISDN or SIP line can also alter the number.

1.5.2 Handling the calling party ID

The configuration options for the call router offer numerous options for manipulating the telephone numbers that are used to establish the connection. The call router usually connects different "telephone worlds" (internal and external,

SIP and ISDN) that use completely different telephone number ranges. In order for the subscribers to communicate successfully with one another, the telephone numbers at the interfaces need to be configured in such a way that, on the one hand, the required subscriber is reached via the correct line and, on the other hand, a return call can be placed successfully (automatically upon "busy", if need be). To enable this return call, the calling number (calling party ID) has to be modified **after** processing by the Call Manager and directly before it is delivered to the relevant subscriber.

Handling outgoing calls

The telephone numbers of outgoing calls are translated depending on the line that is used:

SIP lines

The treatment of the calling-party ID on SIP lines depends upon the line's operating mode:

- Individual account: In the case of an outgoing call over a SIP line, the calling party ID is converted to the number that was entered for the SIP line (SIP ID).
- Trunk and gateway: Please observe the information in section SIP mapping.

SIP PBX lines

In the case of an outgoing call over a SIP PBX line, the subscriber is registered at the upstream SIP PBX and is part of the telephone number range there. This is why the calling party ID—which represents the internal telephone number or "extension" of the subscriber in this case—is passed unchanged to the SIP PBX line.

ISDN lines

In the case of an outgoing call over an ISDN point-to-multipoint connection, the calling party ID is converted to the MSN that is entered for the subscriber (or the internal telephone number) in the ISDN mapping table.

If this does not contain an entry for the number that is currently calling, no calling party ID is sent. Similarly, no calling party ID is sent if CLIR (Calling Line Identifier Restriction) is activated.

Handling incoming calls

The telephone numbers of incoming calls are translated differently depending on the SIP or ISDN subscriber criteria and whether automatic outside line access is active or not.

The calling party ID is changed depending on the following parameters:

- The prefix ("call prefix" or "Cln-Prefix") that is stored for the **line** (default: <blank>).
- The prefix for internal connections with destination ISDN users ("internal ISDN prefix" or "Intern-Cln-Prefix" - default: '99').
- The prefix for internal connections with destination SIP users ("internal SIP prefix" or "Intern-Cln-Prefix" - default: '99').
- The prefix for external connections with destination ISDN users ("external ISDN prefix" or "Extern-Cln-Prefix" - default: <blank>).
- The prefix for external connections with destination SIP users ("external SIP prefix" or "Extern-Cln-Prefix" - default: <blank>).

The activation of automatic outside line access is taken into account by configuring the prefixes appropriately:

- If automatic outside line access is activated, the internal prefixes are typically set to the dial character that is used to reach the internal subscriber, usually '99' or '*'.
 - Without automatic outside line access, the external prefixes are typically set to '0'.

The calling party ID is only supplemented if the incoming call has a calling party ID. If the calling party ID is blank, no prefix is attached.

It is modified as follows:

- With internal connections, the internal subscriber prefix (SIP or ISDN) is placed in front of the calling party ID.
- With external connections, depending on the (line) call prefix, the following decision is made:

- (Line) call prefix blank: The external subscriber prefix (SIP or ISDN) is placed in front of the calling party ID.
- (Line) call prefix not blank: The internal subscriber prefix (SIP or ISDN) and the (line) call prefix is placed in front of the calling party ID.



A call is regarded as external if it comes from a "line". If this line is a SIP PBX line, then the call is only external if the incoming calling party ID is preceded by a '0'.

1.5.3 Call-routing table parameters

You configure the call-routing table entries in the LANconfig under **Voice Call Manager > Call router** by clicking on the button **Call routing**.

An entry in the call routing table consists of:

- Conditions that have to be met so that the entry is "considered" appropriate. These include:
 - Information about which subscriber is to be called; called number/name (Called Party ID), called domain (if applicable).
 - Information about the calling subscriber; calling number/name, calling domain, source line through which the call reaches the LANCOM VoIP router.
- Instructions regarding the procedure for the call:
 - How is the telephone number translated and modified for further processing?
 - Which line should be used to place the call (destination line)?
 - Which backup lines should be used if the destination line is not available?

The entries are searched row by row; the first suitable entry is performed. For this reason the special entries should be configured first of all, followed by the general entries.

If an entry is found in the call routing table with the destination line "RESTART", then the entire pass starts again with the new, translated called party ID. The entry for the source line (calling line) is deleted for the next pass.

Both the call routing table and the local subscriber table may contain and process alphanumeric names where this makes sense.

Active entry/default line

The routing entry can be activated, deactivated, or marked as a default entry. All calls that can be resolved using the first passes but not using the call routing table or local subscriber table are then automatically resolved using these default entries. You can use any destination name and destination domain; only any source filters that you have set will be processed.

Priority

The Call Manager sorts all entries with the same priority automatically, so that the table can be processed through logically from top to bottom. With some entries, however, the sequence of the entries has to be specified (for the telephone number translation, for example). The entries with the highest priority are automatically sorted to the top.

Called number

The called party name or destination telephone number (without domain information) that is called.

The # character is used as a placeholder for any character strings. All characters in front of the '#' are removed, the remaining characters are used in the "Number/name" field instead of the # character to further establish the connection.

Example: The call routing table contains entry '00049#' as the called number/name and '00#' as the number/name. For all calls with a preceding '0' for outside-line access and the complete dialing code for Germany, only the leading '0' for the outside-line access and the leading '0' for the local area dialing code are retained as the number/name; the country ID is removed. So '00049 2405 123456' becomes '0 02405 123456'.

Independently of this, an alphanumeric number can also be specified.

Comment

Comment on the current routing entry

Calling number

If the calling number is to be replaced by another number in the call route, the desired number must be entered in this field. If the special value "EMPTY" is selected and the filter field **Calling number** is filled with any character (e.g. wildcard #) at the same time, a number suppression for outgoing calls can be configured for the call route.

Destination number

This telephone number is used to continue with establishing the connection. If no connection can be established using this telephone number and the corresponding line, then the backup telephone numbers with their associated lines are used

At least one of the fields **Destination number**, **2nd dest. number** or **3rd dest. number** must have content. They are evaluated in this sequence. A blank field is skipped.

Destination line

The connection is established using the destination line. Normal destination lines can be:

- > ISDN
- > All defined SIP lines.

The following special functions can be entered as a destination line:

- > REJECT highlights a blocked telephone number.

 This value also allows you to *prohibit control characters on SIP lines*.

- > USER forwards the call to local SIP or ISDN subscribers.
- > RESTART begins a new pass through the call-routing table with the previously formed **Destination number**. The former **Source line** is deleted.

 This field has to be completed, otherwise the entry is not used.

2nd Destination number, 3rd Destination number

This telephone number is called if nothing is entered in **Destination number** or the corresponding "line" is not available. If the 2nd destination number and the corresponding 2nd destination line are not available, then the 3rd destination number and the corresponding 3rd destination line will be used instead.

Called domain

This entry filters the called domain, the "Called Party Domain". The call router entry is only considered to match if the Called Party Domain for the call matches the domain that is entered here. If nothing is specified, any destination domain is accepted.

The following can be entered as called domains:

- > ISDN
- > The internal VoIP domains of the LANCOM VoIP router.
- > All domains entered for the SIP and SIP-PBX lines.

Calling number

This entry filters the calling number/name, the "calling party ID". It is specified as an internal number or as a national or international telephone number. The domain is not specified. No '0' or other character for a line ID is prefixed; the ID is used as if it comes from the line or from internal telephone calls.

The call router entry is only evaluated as matching if the Calling Party ID for the call matches the number that is entered here. After '#', any characters can be accepted. If nothing is specified here, any Calling Party ID is accepted.

 The following special functions can be entered as a calling number:

- > EMPTY can be used for Calling Party IDs that are not specified.

Calling domain

This entry filters the "calling domain". The call router entry is only considered to match if the Calling Domain for the call matches the domain that is entered here. If nothing is specified, each calling domain is accepted.

The following can be entered as calling domains:

- > ISDN
- > The internal VoIP domains of the LANCOM VoIP router.
- > All domains entered for the SIP and SIP-PBX lines.

SIP telephones usually have several line keys, for which different domains can be configured. With this filter, telephone calls are handled depending on the selection that is made using different line keys.

Source line

This entry filters the source line. The call router entry is only considered to match if the source line for the call matches the line that is entered here. If nothing is specified, any calling line is accepted.

The following can be entered as the source line:

- > USER.ISDN for calls from a local ISDN subscriber

- > USER.SIP for calls from a local SIP subscriber
- > USER # for calls from a local subscriber in general
- > All ISDN, SIP and SIP-PBX lines that are entered.

Prohibit control characters on SIP lines

This prevents the dialing of control characters. Control codes can, for example, be used to configure call forwarding. You can prevent this for any particular lines or persons. For example, proceed as follows to reject the character '#':

1. Under **Called number:** enter ##.
2. Under **Destination number:** enter #.
3. For the **Destination line** select REJECT.
4. Enter a **Comment**, e.g. "No numbers beginning with #".

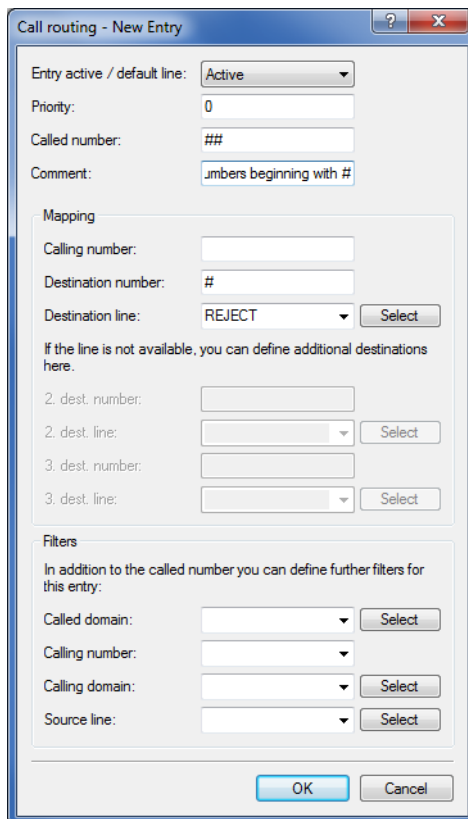

5. Confirm your settings by clicking the **OK** button.

Group call functions

You configure the call-routing table entries in LANconfig under **Voice Call Manager > Call router** by clicking on the button **Call routing**.

Entry active

Activates or deactivates the entry.

Internal telephone number

The hunt group is available under this telephone number or SIP-ID (max. 64 alphanumerical characters).

 The names of hunt groups may not coincide with the names of users (SIP, ISDN, analog).

Comment

Comment about this entry (64 characters)

Members

Comma-separated list of the members of the hunt group. Members can be users, hunt groups or external telephone numbers, and so there is no limit on scaling.

- > Possible members: Users, hunt groups, external telephone numbers
- > Possible values: Maximum 128 alphanumerical characters.

 A hunt group may not contain itself or any parents in the hierarchical system—recursion through member entries is not possible. However, loops to parents in the structure may result from the "forwarding target".

Call distribution

Sets the type of call distribution:

- > Simultaneous: The call is signaled to all group members at once. If a member picks up the call within the call-forwarding time, the call is no longer signaled to other group members. If nobody accepts the call within the forwarding time, then the call is switched to its forwarding destination.
- > Sequential: The call is directed to one member of the group after the other. If a group member does not accept the call within the forwarding time, then the call is switched to the next member of the group. If nobody in the group accepts the call within the forwarding time, then the call is switched to its forwarding destination.

Forwarding time

If an incoming call is not picked up by a group member within the forwarding time, then the call is forwarded according to the distribution method selected:

- > In the case of simultaneous call distribution, the call is forwarded to the forwarding destination.

- In case of sequential call distribution, the call is forwarded to the next group member in line. If the group member is the last one in the sequence, then the call is redirected to its forwarding destination.
- Possible values: Max. 255 seconds.
- Default: 0 seconds
- Significant values: 0 seconds. The call is forwarded immediately to the forwarding destination (temporarily jumps a hunt group in a hierarchy).

 If all members of the group are busy or unavailable, then the call is redirected to the forwarding destination without waiting for the forwarding-time to expire.

Forwarding destination

If none of the group members accepts the call within the forwarding time, then the call is switched to the forwarding destination entered here. Forwarding destinations can be users, hunt groups or external telephone numbers. Only one forwarding destination can be entered.

- Possible destinations: Users, hunt groups, external telephone numbers
- Possible values: Maximum 64 alphanumerical characters.

 If no forwarding destination is defined, then the call is rejected as soon as the member list has been worked through, or if all members are busy or unavailable.

The forwarding destination only becomes active once the group's forwarding time has expired or if no members are available. Here, too, redirection to a higher level of the hunt-group structure is possible, unlike with the "Members" entry.

1.5.4 Signaling parallel calls in the ISDN

LANCOM business VoIP routers are able to make parallel calls. If you use this feature, signaling occurs on both ISDN lines (ISDN 1 & ISDN 2). The call is accepted at the first telephone to pick up the call.

To enable parallel calls, navigate to **Voice call Manager > Users > ISDN users**.

In the **ISDN parameters** section and under **ISDN/S0 bus**, select the option “ISDN 1 & ISDN 2” and then set the item **Parallel call** to “On”.

1.5.5 Extended settings

To configure the advanced settings for the VoIP Call Manager, navigate to **Voice Call Manager > Extended**.

Country specific profile for:

T.38 transcoding:

Choose when to use T.38 transcoding for fax transmission.

SIP parameters

Echo cancelling from SIP to ISDN/Analog

Convert canonical call numbers

Prefixes for displaying the calling number of incoming calls

From internal to SIP user:

From external to SIP user:

From internal to ISDN user:

From external to ISDN user:

From internal to analog user:

From external to analog user:

Quality of Service

Prioritize SIP packets by changing the other packets:

Prioritize outgoing packets:

Prioritize incoming packets:

Reduced packet size (MTU): byte

SIP DiffServ codepoint (DSCP):

RTP DiffServ codepoint (DSCP):

Country specific profile for

This allows you to select a profile for a specific country, which provides the default input values.

Echo canceling from SIP to ISDN

Activates the echo canceling of remote echoes. With an echo that is too strong, subscribers can hear their own voices after a short delay. Activating this option reduces the ISDN echo at the SIP ISDN gateway.

Prefix from internal to SIP user

If an incoming **internal** call is directed to a SIP user, this prefix is added to the calling party ID, if available.



A call is regarded as external if it comes from a "line". If this line is a SIP PBX line, then the call is only external if the incoming calling party ID is preceded by a '0'. All other calls are regarded as internal.

Prefix from external to SIP user

If an incoming **external** call is directed to a SIP user, this prefix is added to the calling party ID, if available.

Prefix from internal to ISDN user

If an incoming **internal** call is directed to an ISDN user, this prefix is added to the calling party ID, if available. If a line prefix is defined, this is placed in front of the whole of the called number.

Prefix from external to ISDN user

If an incoming **external** call is directed to an ISDN user, this prefix is added to the calling party ID, if available. If a line prefix is defined, this is placed in front of the whole of the called number.

Prefix from internal to analog user

This prefix is added to the calling party ID, if available, for an incoming, **internal** call if the call is directed to an analog user. If a line prefix is defined, this is placed in front of the whole of the called number.

Prefix from external to analog user

If an incoming **external** call is directed to an analog user, this prefix is added to the calling party ID, if available. If a line prefix is defined, this is placed in front of the whole of the called number.

Prefer outgoing packets

For all SIP calls, sufficient bandwidth through the firewall is reserved as required by the audio codec being used (provided sufficient bandwidth is available). To control the firewall, you can configure how the remaining data packets that do not belong to the SIP data stream are handled. The following values are possible:

➤ PMTU reduction

The subscribers of the data connection are informed that they should only send data packets up to a certain length (Path Maximum Transmission Unit, PMTU).

➤ Fragmentation

The LANCOM wireless router reduces the data packets by fragmenting them to the required length.

➤ No change (Default)

The length of the data packets is not changed by the VoIP operation.

For more information, see the description of PMTU and fragmenting with regard to quality of service.

Prefer incoming packets

Similar to the outgoing data packets, you configure how non-VoIP data packets are handled when bandwidth is reserved for SIP data. The following values are possible:

➤ PMTU reduction

The subscribers of the data connection are informed that they should only send data packets up to a certain length (Path Maximum Transmission Unit, PMTU).

- > No change

The length of the data packets is not changed by the VoIP operation.

Reduced packet size

This parameter specifies the packet size that should be used for PMTU adjustment or fragmentation while the SIP data have priority.

SIP-DiffServ-CodePoint (DSCP), RTP-DiffServ-CodePoint (DSCP)

The Voice Call Manager marks SIP and RTP packets with DiffServ CodePoints (DSCP), which enables other hardware to recognize and prioritize these packets.

By default, SIP packets (call signaling) are marked with 'CS-1' and RTP packets (voice data stream) are marked with 'EF'. Here you have option to change this behavior. With the setting 'DSCP BE' or 'CS-0' the packets are sent unmarked. Further information on the DiffServ-CodePoints is available in the Reference Manual in the section **Quality of Service**.



The option 'CS-1' for SIP DSCP is actually outdated now, but it is the default value to ensure backwards compatibility. Common values for modern VoIP installations are 'CS-3', 'AF-31' or 'AF-41'. We recommend using 'CS-3', one of the most widespread settings on the market for use with SIP DSCP.

1.6 Telephony (PBX) functions in LANCOM VoIP routers

A LANCOM VoIP router provides telephony functions for small companies and company branch offices:

- > Telephony functions such as call hold, swap, transfer or redirect
- > Hunt group function with flexible call distribution and cascading of hunt groups
- > Multiple logins to use various telephones under one telephone number



Please note that the extent to which features such as connect call and automatic call forwarding (redirection) are supported by SIP providers can differ greatly. It is impossible to guarantee that this function will work properly with all combinations of SIP devices and SIP providers.

1.6.1 Transfer and forward call

The integration of SIP telephones and VoIP routers into existing telephone structures means that we have to take a fresh look at familiar functions such as forwarding calls. Call forwarding means that a call that has already been placed (routed) is redirected to a new destination either spontaneously by the user (connect call) or by automatic call forwarding set up in advance. SIP-based VoIP telephony uses processes which are fundamentally different to previous technologies. For example, ISDN and analog terminal devices require a telephone exchange that usually has to continue to manage the connection after forwarding. SIP telephones can forward calls without any need of a telephone exchange: The devices make a connection over the shortest possible route and the call router stops its management function immediately after the connection has been established. The SIP exchange is also able to handle signaling over SIP and the actual data transfer over RTP in different ways.

Due to the differences arising from the various types of terminal device, the easiest way to understand call forwarding in a LANCOM VoIP router is to consider different scenarios and to explain the terminology.

Active and passive forwarding

When looking at the technical details, it is important to consider the end from which call forwarding is initiated. "Local" users are all SIP, ISDN or analog users who can be reached by the LANCOM VoIP router in their own LAN. "External" users are those accessible via a line (SIP account, SIP trunk, SIP PBX, ISDN or analog).

- Active: A local subscriber initiates call forwarding.
- Passive: An external subscriber initiates call forwarding

Call forwarding with and without consulting

A subscriber forwarding a call can either directly hand over an active call to a third subscriber (unattended call forwarding), or a separate call can be made to the third subscriber to communicate the call and then hand it over (attended call forwarding).



LANCOM VoIP routers support unattended call transfer only via the SIP protocol.

Charges for calls when forwarding to external users

The forwarding of a call from an external caller to a third party who is also external carries the risk that charges will arise for the ongoing call, even though the initiating subscriber has ended the call.

How the LANCOM VoIP router handles call forwarding

Irrespective of which terminal devices are involved in the call forwarding, a LANCOM VoIP router can handle a variety of tasks:

Passthrough

Both subscribers in the call forwarding are at the same end of the connection, e.g. transfer from a local to a local subscriber.

Delegate

The call forwarding is not handled by the LANCOM VoIP router itself but by an upstream exchange, e.g. in a VoIP PBX that is accessible via a PBX line.

Switching

The LANCOM VoIP router handles the signaling and the data transfer between subscribers.

Active forwarding to local users

1. An external user **A** makes a call to an internal user **B** (SIP, ISDN or analog).
2. **B** makes a further call to local user **C**. These two users can reach each other directly, so the LANCOM VoIP router only handles the signaling by means of SIP; the data transfer via RTP takes the shortest possible route.
3. Local user **B** initiates the call forwarding (attended/with flash) to **C**.

- The LANCOM VoIP router manages the call forwarding.

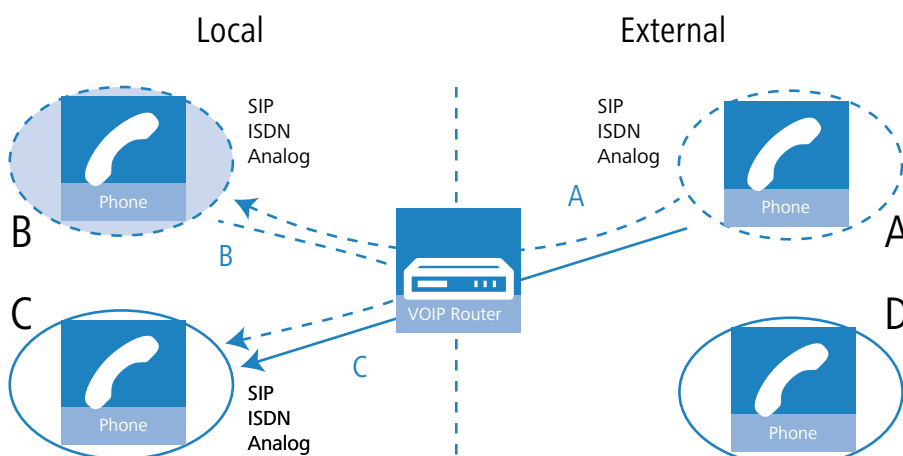

ⓘ In case of SIP at the external subscriber, this requires that Transfer in SIP (re-invites) is fully supported.

Active forwarding to external SIP users

- An external SIP user **A** makes a call to an internal user **B** (SIP, ISDN or analog).
- B** makes an additional call to an external user **D**.
- If both external users **A** and **D** can be reached via the same SIP line, the LANCOM VoIP router delegates the administration of the call forwarding to the upstream provider.

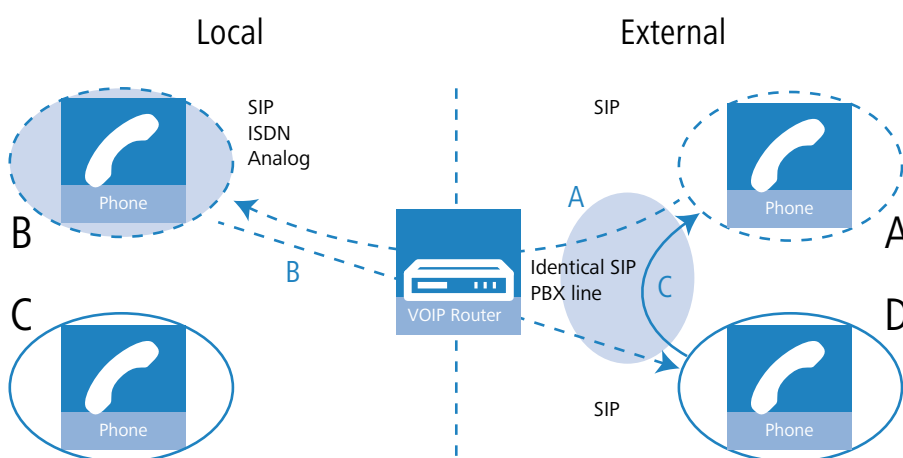

ⓘ Requires that the VoIP PBX fully supports Transfers in SIP (re-invites).

Active forwarding to external ISDN users

In some cases upstream exchanges do not support the delegation of call forwarding to external ISDN users, often due to the unclear situation about who carries the call charges. For this reason, call forwarding between external subscribers is always handled by the LANCOM VoIP router.

- An external subscriber **A** (external SIP, ISDN) makes a call to an internal user **B** (SIP, ISDN).
- B** makes a further call to an external subscriber **D** (ISDN or analog).
- The local user **B** then forwards the call (with consultation) to **A**.
- If both external users **A** and **D** use different protocols (SIP, ISDN), the LANCOM VoIP router assumes responsibility for managing and converting the data.

- If both external users **A** and **D** use SIP, the LANCOM VoIP router is unable to forward the call.

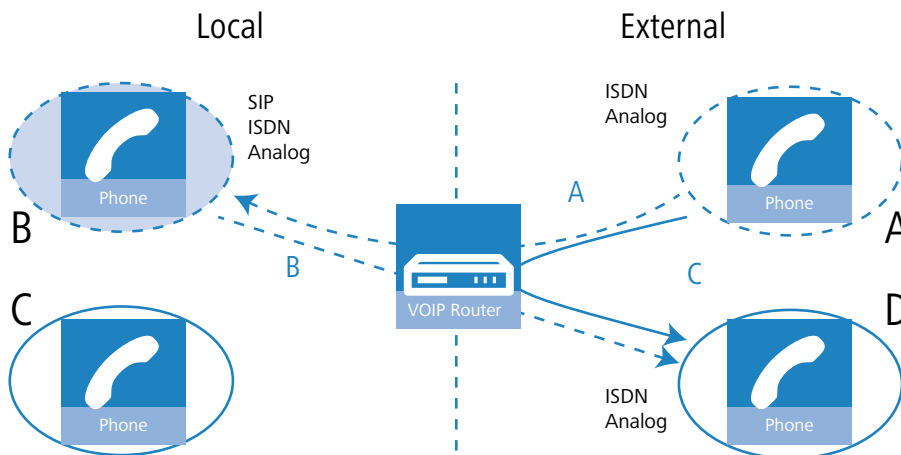

⚠ Requires that the VoIP PBX fully supports Transfers in SIP (re-invites).

Passive forwarding between local users

- An internal user **B** (SIP, ISDN or analog) calls an external user **A** (at a SIP PBX line).
- A** makes an additional call to a local user **C**.
- The external user **A** then forwards the call to **C**.
- The LANCOM VoIP router manages the call forwarding. If the connected subscribers **B** and **C** are internal users, the LANCOM VoIP router only checks the SIP data for signaling and enables the RTP data transfer over the shortest direct path between the SIP users.

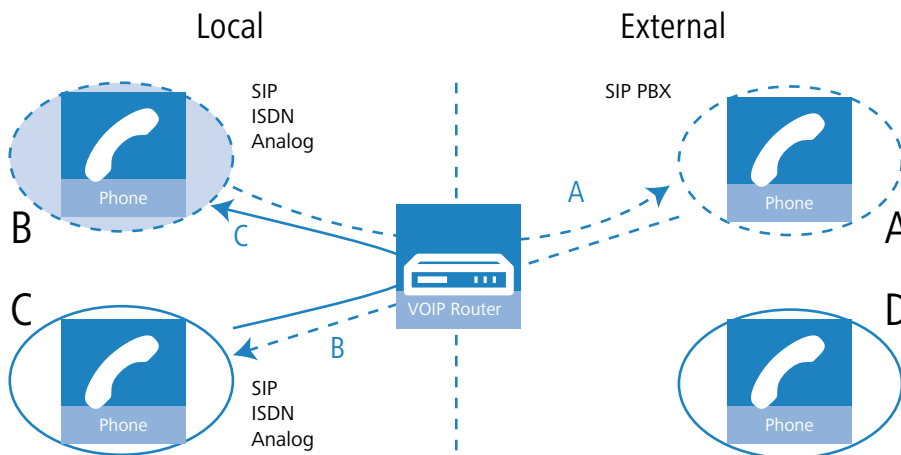

⚠ Requires that the VoIP PBX fully supports Transfers in SIP (re-invites).

Passive forwarding from local to external users

- An external user **A** (at a SIP PBX line) makes a call to an internal user **B** (SIP, ISDN or analog).
- A** makes an additional call to an external user **D** (who is also a subscriber to the same SIP PBX line as **A**).
- The external user **A** then initiates a connect from **B** to **D**. The LANCOM VoIP router needs to establish a connection to **D** for this.

! The LANCOM VoIP router can only establish this connection if **D** can be reached via the same SIP-PBX line as **A**, i.e. if external call forwarding is permitted.

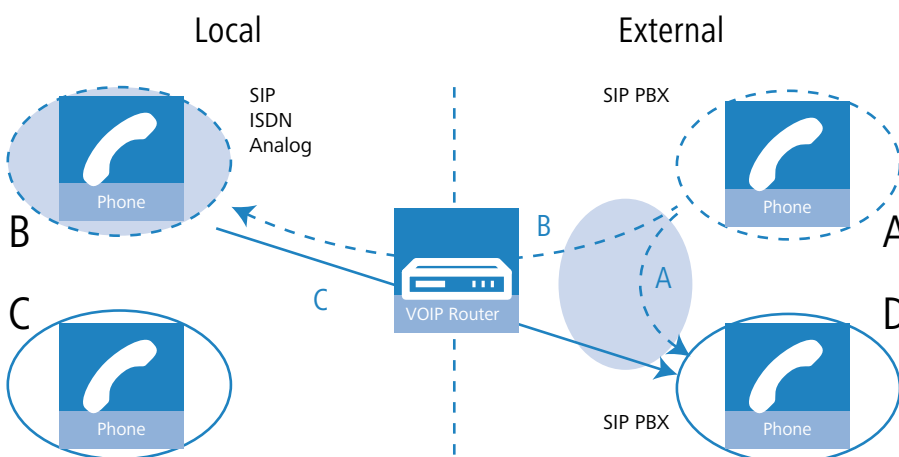

! Requires that the VoIP PBX fully supports Transfers in SIP (re-invites).

1.6.2 Spontaneous call management by the user

Functions for spontaneous call management

Calls can be managed on an individual basis and the LANCOM VoIP router supports the services known from the ISDN network:

- > With call hold the user can place an active call into a wait state. In this state the user can make a call to another person, for example.
- > Establishing an additional call while a call is on hold is referred to as consulting. This call can be ended again and the conversation with the call on hold continued.
- > With swap call, the user can switch to and fro between two connections. The user is only connected with one caller at a time, while the other caller is put on hold.
- > With call swap the user switches an active call over to another call which is on hold. The two callers are then connected and the user is no longer involved in the call. A subscriber forwarding a call can either directly hand over an active call to a third subscriber (unattended call transfer), or a separate call can be made to a third subscriber to communicate the call and then forward it (attended call transfer).

Using spontaneous call management with various telephones

SIP telephones and SIP softphones generally feature special keys or menu entries to manage calls. Different terms may be used depending on the model or software program, but the functions are as follows:

- > CALL HOLD: Places an active call into a wait mode or swaps between two active calls. On ISDN and analog telephones this function is often referred to as the F-key/Flash/Call hold function (F key).
- > HANG UP: End the current call.
- > SWAP: Swap between two active calls (depending on the ISDN telephone, this may be initiated by a display-menu entry, a special key, or the "F" key).
- > TRANSFER: Initiates the call forwarding (can be triggered by "hanging-up" with an active call and a call on hold)¹.

These functions can be used to manage calls as follows:

Holding/consulting and continuing with calls	SIP	ISDN	Analog
To place a call on hold, press the Flash/Call hold key (or "F" on analog phones).	CALL HOLD	HOLD or F	R

1 Voice over IP – VoIP

Holding/consulting and continuing with calls	SIP	ISDN	Analog
The caller can no longer hear you and you can initiate a second call by dialing a telephone number (consulting).			
To continue with a call which is on hold, press the Flash/Call hold key again (or "F 2").	CALL HOLD	HOLD or F	F 2
If the consultation call has not yet been picked up, you can stop the consulting by hanging up the handset on a SIP or ISDN telephone. ¹	HANG UP (1st call rings)	HANG UP (1st call rings)	R 1 (back to 1st call)
You can stop the consultation call with the appropriate menu function of the telephone (e.g. "Cancel") or "F 1" (analog). ¹			

Swap	SIP	ISDN	Analog
To open a second line during a call, first press the Flash/Call hold key (or "F" on analog phones).	CALL HOLD	HOLD or F	R
The other caller can no longer hear you.			
Dial the number for the second caller while the first call is on hold.	123456789	123456789	123456789
If you cannot reach the second caller, you can return to the call which is on hold by pressing the hold key (or "F" on analog telephones).			
As soon as two simultaneous connections are open, you can use the hold key (or swap key for ISDN phones, "R" and "2" for analog phones) to swap to-and-fro between the two connections.	CALL HOLD	CALL HOLD / SWAP	F 2
You will be connected to one of the other callers; the other caller is placed on hold.			
To end an active call, hang up the handset on SIP or ISDN telephones, and on analog phones press "R 1".	CANCEL or HANG UP ¹	CANCEL or HANG UP ¹	F 1
The call which is on hold is not automatically reactivated, but it will be signaled (ringing phone) for a period of 15 seconds.			

Call forwarding, consult	SIP	ISDN	Analog
To open a second line during a call, first press the Flash/Call hold key (or "F" on analog phones).	CALL HOLD	HOLD or F	R
The other caller can no longer hear you.			
Dial the number for the second caller while the first call is on hold.	123456789	123456789	123456789
If you cannot reach the second caller, you can return to the call which is on hold by pressing the hold key.			
As soon as you have established two simultaneous connections you can connect the two callers with the connect key (or "F" and "4" on analog phones) or by hanging up the handset. ¹	TRANSFER or HANG UP ¹	TRANSFER or HANG UP ¹	R 4 or HANG UP
Optionally you can switch between the two lines as often as you like before transferring the call. Call transfer always connects the active call and the call on hold.			

Call transfer, blind	SIP
To open a second line during a call, first press the Flash/Call hold key.	CALL HOLD
The other caller can no longer hear you.	
Dial the number for the second caller while the first call is on hold.	123456789

Call transfer, blind	SIP
Press the connect key or hang-up the handset before the second connection has been established. ¹	TRANSFER or HANG UP ¹
The two callers will now be connected "in the background".	

1.6.3 Configure permanent call forwarding

Along with spontaneous call transfers as controlled by a subscriber during a call, it is often useful to set up a permanent call forwarding ("redirect calls"). For example, a call should be forwarded when a line is busy, if there is no answer within a certain period, or in case of absence (e.g. vacation).

There are two possibilities for configuring permanent call forwarding.

- Via the telephone or terminal device itself with the aid of control characters
- In the configuration of the LANCOM VoIP router by means of the management tools (LANconfig, WEBconfig or telnet)

 If permanent call forwarding is activated by both methods, then the behavior of the call forwarding follows the last respective action.

Triggering call forwarding

The following events can be used as a trigger or condition of the permanently configured call transfers:

- CFU, call-forwarding unconditional
- CFB, call forwarding on busy
- Delayed call forwarding, CFNR (call forwarding no reply); CFNA (call forwarding no answer)
- No call transfer

All types of call forwarding can be used in parallel with your own destination telephone numbers. If multiple call-forwarding conditions are active, the following priority applies:

1. CFU
2. CFB
3. CFNR

If call forwarding on busy is activated and a corresponding destination number has been defined, for example, then the call will be forwarded to this number before using the number set for call forwarding on no reply.

 If the incoming call has already been forwarded from another telephone number, then forwarding will not take place again, so as to avoid endless call-forwarding loops.

Configuring user settings with the telephone with character strings

For the configuration of user settings with the telephone, the various technologies (SIP, ISDN, analog) each offer specific possibilities. With ISDN telephones, call forwarding can be controlled by the functional protocol in the ISDN signaling or via so-called keypads (character strings). For analog telephones the same character strings are transferred by DTMF. The SIP protocol provides another option with its REFER method that is supported by most SIP phones and SIP softphones. However, call forwarding can only be controlled by the terminal device. To enable a uniform behavior for users in mixed infrastructures, the LANCOM VoIP router offers an further variant of call forwarding for SIP phones. This is presented here in comparison with ISDN and analog telephones.

Immediate call forwarding	SIP	ISDN	Analog
Switch on and define destination for call forwarding	*21*TargetNo#	*21*TargetNo#	*21*TargetNo#
Switch off	#21#	#21#	#21#

1

 In some cases, SIP or ISDN telephones can be configured so that hanging-up the handset either causes the consultation or active call to terminate, or a call forwarding is triggered ("Transfer").

Immediate call forwarding	SIP	ISDN	Analog
Switch off temporarily, maintain call-forwarding destination	#22#	#22#	#22#
Switch on again, maintain defined call-forwarding destination	*22#	*22#	*22#

Call forwarding on busy	SIP	ISDN	Analog
Switch on and define destination for call forwarding	*67*TargetNo#	*67*TargetNo#	*67*TargetNo#
Switch off	#67#	#67#	#67#

Call-forwarding on no reply	SIP	ISDN	Analog
Switch on and define destination for call forwarding	*61*TargetNo#	*61*TargetNo#	*61*TargetNo#
Switch off	#61#	#61#	#61#

Please note the following when using character strings to configure call forwarding:

-  Some ISDN telephones feature special keys or menu entries to configure call forwarding, and these can be used as an alternative to the listed character strings. Refer to the documentation from the corresponding manufacturers.

1.6.4 Call forwarding (call deflection / partial rerouting) at the SIP trunk (SIP 302)

LANCOM routers operating the Voice Call Manager can initiate call forwarding on SIP trunk connections by forwarding the information sent by the PBX to the SIP trunk provider. If this is an ISDN terminal, the partial rerouting (PR) is converted into a "SIP 302 Moved Temporarily" before being transmitted to the provider.

In the SIP lines table, the external call forwarding is configured for each individual SIP trunk line under **Voice Call Manager > Lines > SIP lines > Advanced** by enabling the option **Call forwarding using SIP 302**. With call forwarding enabled, a call-forwarding option initiated from a telephone (ISDN / SIP) is switched directly at the exchange, unless the telephone is part of a call number group or the user is registered multiple times on the LANCOM router.

If the telephone is an ISDN terminal, the partial rerouting is converted by means of the service feature SIP 302 before being transmitted to the provider. The number to which an incoming call should be forwarded is transmitted by the terminal and must be reachable via call routes. The phone number must therefore match the dialing plan in the Voice Call Manager in order for the latter to select the correct line. For this reason, line prefixes have to be specified even though they are removed by the Voice Call Manager once the correct line has been selected.

If the forwarding destination set on the terminal is an internal telephone number, the call forwarding is performed by the Voice Call Manager directly, in which case you have to use the prefix used for internal calls (e.g. **).

1.6.5 Fax via T.38 – Fax over IP (FoIP)

The migration of telephone infrastructure towards VoIP has also increased the demand for fax devices to communicate over VoIP. Even in the age of e-mail, fax transmissions continue to be highly important in legal respects as legally binding documents such as contracts and invoices can be far more easily handled by fax than with the alternative of e-mails with digital signature. The integration of fax devices into VoIP infrastructure can be implemented in two ways:

- > Fax messages are transmitted via landline just like a conventional fax.
- > The transmission takes place over an Internet connection. Options for this are as follows:
 - > The fax signals are transmitted like voice data over a VoIP connection, referred to as "fax over VoIP". Fax transmission should only make use of the G.711 codec, as other codecs are inferior at converting the fax tones designed for analog networks into digital VoIP data. Due to the highly sensitive nature of fax connections, this method can only be used with high-quality connections, whereby the transmission speed is sub-optimal.

- For example, with the "store-and-forward" principle (ITU-T.37), fax messages are passed from the fax machine to a gateway that stores and converts the fax document. In a second step the fax is transmitted to the destination for conversion back into a fax format. Alternatively fax messages can be sent by e-mail (fax-to-mail and mail-to-fax). Solutions of this type may not meet the legal requirements mentioned above, due to the fact that there is no direct connection between transmitter and receiver.
- With "real-time routing" of fax messages, on the other hand, a direct connection is established between the two fax machines and all data is transferred in real time. The fax machines are connected virtually over the Internet. Communication between the two fax machines follows the ITU-T.38 standard for converting standard fax signals. This variant is also known as Fax over IP (FoIP). The fax messages are not transferred as acoustic signals via VoIP, but rather in a special protocol, that embeds the signals in UDP/TCP packets.

To enable fax transmissions with T.38, the fax machines themselves either have to support the T.38 standard or they must be interconnected over the Internet via fax gateways. LANCOM VoIP routers support the T.38 standard and are thus suitable for operation as fax gateways in VoIP infrastructure.

The fax machines are connected to the LANCOM VoIP routers by means of a suitable interface. The fax gateway in the LANCOM VoIP router handles the conversion of the signals for transmission and reception of fax messages:

- Conversion of T.38 fax data to G.711/T.30
- Conversion of G.711/T.30 fax data to T.38
- Passthrough of G.711/T.30 fax data
- Passthrough of T.38 fax data

If the device type "fax" or "telephone/fax" is selected in the user settings of the ISDN or analog user, the LANCOM Business VoIP router automatically recognizes a fax for transmission and it attempts to transmit via F.38/FoIP. If the remote site does not support this method, the LANCOM VoIP router automatically uses the fax over VoIP-version using G.711 compression.



Successful transmission of fax via FoIP requires that the VoIP infrastructure also supports the T.38 standard. For example, where a public SIP provider is involved, this provider also has to offer T.38 support.

1.6.6 Hunt groups with call distribution

Introduction

Calls are normally intended for an individual or their telephone number. Occasionally it is not important to speak to a particular individual, but to anybody in a certain department or with a certain function. In this case, telephone infrastructure collects multiple users into hunt groups where they can all be reached under a single shared telephone number. The group call function can then follow certain rules to distribute or forward incoming calls to the call group.

Call distribution

A hunt group consists of two or more users, or even other hunt groups, as potential destinations for an incoming call. Hunt groups are comparable to local users and have their own number and, as such, they can be used as a destination number in the call router.

Incoming calls can be distributed by a variety of methods, allowing different scenarios to be realized.

- Calls are signaled to all group members at the same time (simultaneous)
- Calls are signaled to one member of the group after the other, in a set order (sequential)

Along with the members of the hunt group and distribution method, also to be defined are a call-forwarding time and call-forwarding destination, all of which control the call-distribution procedure. The forwarding time determines the time period during which the dialed user can answer a signaled call. The forwarding destination defines where the call is to be forwarded to (user, group, internal or external call number) for the case that none of the group members picks up the call within the forwarding time—if no forwarding destination is defined, then the call is rejected.

Cascading of hunt groups

The defined hunt groups can themselves be members of a higher-level hunt group, just as hunt groups can be entered as the forwarding destination for a higher-level hunt group. These options enable the establishment of a cascaded hunt-group structure which can form highly complex scenarios by using a multitude of branches. These branches represent the hunt groups and the end points are the users themselves. The following rules apply to structures of this type:

- If a hunt group is used as a member, then this lower-level hunting group causes a new "branch" in the structure to open up when that member receives a call.
- When a lower-level hunt group opens, certain parameters that have been defined, e.g. forwarding time, etc., apply.
- This branch from the lower-level group only remains open for as long as the member in the upper-level hunt group is being signaled according to the settings. If the next member in the upper-level hunt group is reached, then the entire branch along with all of its other sub-branches is closed. The system does not wait until all possible combinations along the branch have been tried out. It is thus possible that there are members defined in a lower-level hunt group who cannot be reached because of settings in the upper-level groups.
- If a member of a hunt group picks up the call, all open branches are closed and all attempts to reach forwarding destinations are stopped.
- If a call remains unanswered after signaling all of the members of an (upper or lower-level) hunt group, then the call is passed on to the call-forwarding destination. This means that any call-forwarding times which may be running in the upper-level hunt groups are ended. In this case the call "jumps" out of the hunt-group structure and is given a new destination.

Example: The following hunt groups have been defined:

Group call number	Comment	Members	Forwarding method	Forwarding time	Forwarding destination
100	Entire company	200, 300, 400	Simultaneous	10	Ext. Dialup remote
200	Service Dept.	201 to 209	Simultaneous	10	100
300	Marketing Dept.	301 to 309	Sequential	10	200
400	Sales Dept.	409	Sequential	15	100
410	Sales Europe group	411, 412, 413, 414, 415	Sequential	10	400
420	Sales America group	421, 422, 410	Sequential	30	400
430	Sales Asia group	431, 432, 410	Sequential	30	400

Each department or group has users who use the final digits in the telephone number, i.e. 411 to 419 for the Sales Europe staff and 409 for the Sales team secretary. Only the group call numbers are communicated externally because all staff members tend to travel frequently on business. The purpose of the hunt-group structure is to connect each customer with a competent staff member in the shortest possible time.

An incoming call directed to the telephone number 420 for a Sales America team member is handled as follows:

1. The call is signaled to the users 421 and 422 in this group for 30 seconds each. If there is no answer, then the hunt group 410 is activated for 30 seconds—a member of the Sales Europe team should take care of the customer if no Sales America team members are available.
2. In the Sales Europe team, calls are distributed to each number for 10 seconds. The hunt group has five members, but with a forwarding time of just 10 seconds, not all of the users can be signaled: The branch is only opened for a maximum of 30 seconds by the upper-level group, in this case 420. This is a way of limiting the maximum waiting time for a customer. If the first three signaled members of the lower-level group 410 do not answer, then the call jumps back to the upper-level hunt group 420.
3. There is still nobody available in the upper-level hunt group 420, and so the call is directed to the call-forwarding destination 400.
4. Hunt group 400 directs the call to the team secretary 409. If here nobody answers for 15 seconds then the call-forwarding destination 100 is used, which addresses the entire company.

5. Hunt group 100 calls all of the numbers in the hunt groups 200, 300 and 400 simultaneously. If even then nobody answers within 10 seconds, then the hunt group forwards the call to an external telephone number, for example a 24/7 call center.

1.6.7 Multiple logins (multi login)

For subscribers using multiple terminal devices, e.g. a softphone on PC and a "normal" telephone on the desktop, multiple SIP, ISDN or analog phones all using the same internal telephone number can log on to the LANCOM VoIP router. Multi-login telephones behave like a single user in a hunt group with 'simultaneous' call distribution:

1. Incoming calls are signaled **simultaneously at all** telephones with this internal number.
2. As soon as a call is picked up at one of the telephones, signaling at the other devices stops.
3. Further incoming calls are signaled to all telephones. If one of the telephones reports that it is "busy", the entire multi-login group is considered "busy" if this has been configured under *Extended user settings* on page 51.
4. Outgoing calls can be made from every telephone without limitation.
5. For a multi-login group only one call forwarding setting (call redirection) can be configured. This applies to all telephones and can be set from any telephone.

To use multi-login, multiple telephones can be set to have the same internal telephone number.

1.7 VoIP media proxy – Optimized management for SIP connections

When transferring or forwarding calls between remote subscribers over different SIP lines, the SIP proxy in the LANCOM VoIP router attempts to connect the two callers by means of a REFER or a Re-INVITE. The two external subscribers are not always able to reach one another directly and so the connection may fail. This is because the SIP providers do not make the necessary adaptations, e.g. translation of the destination IP addresses. To improve performance in these situations, the SIP proxy in the LANCOM VoIP routers has been additionally equipped with a media proxy.

The media proxy helps to transfer and forward calls between subscribers who are reachable over different types of telephone line (e.g. SIP PBX line and SIP provider line). The media streams, generally RTP connections, remain unchanged. The media proxy changes the ports and IP addresses in the data packets and it adapts special media end points to the corresponding destination networks (ARF networks, interface and IP address).

Multiple media streams in one SIP connection

The SIP protocol can negotiate multiple data streams in a session, e.g. separate media streams for audio and video. Each stream is handled separately. A data stream initially terminates at the media proxy and continues from the "other side". This provides the data stream with end points at the LAN and WAN sides of the media proxy.

All of the connection information in the direction of the SIP provider can be maintained and all of the necessary changes to IP addresses, ports, etc., are handled by the media proxy.

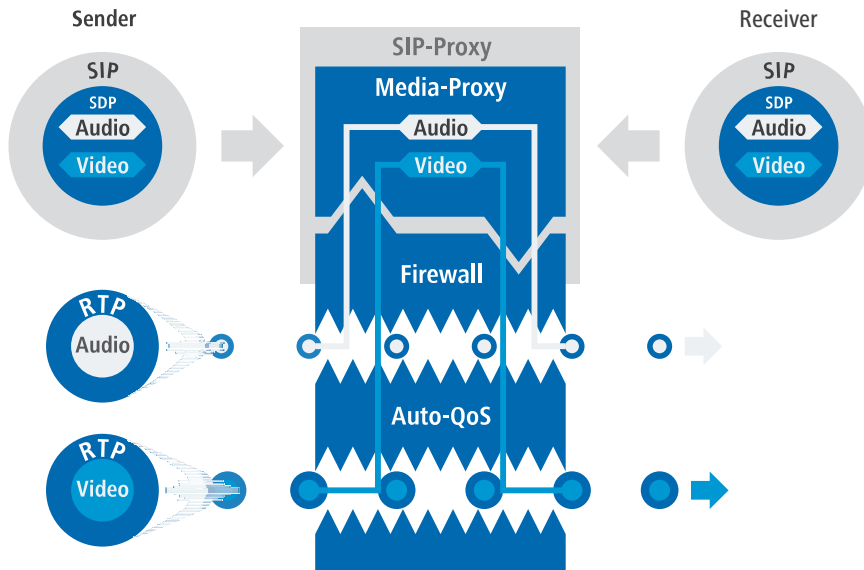

The data streams are all fed through the firewall individually, which enables a differentiated control of the QoS settings, among other things.

Connection management by the media proxy enables all subscribers to be connected to one another, whatever type of line they are using. This makes it possible to connect between SIP, ISDN and analog subscribers, something that a pure SIP connection is not capable of. Furthermore, the monitoring of individual media streams in the firewall allows certain types of application to be permitted or prevented depending on the connection's end point.

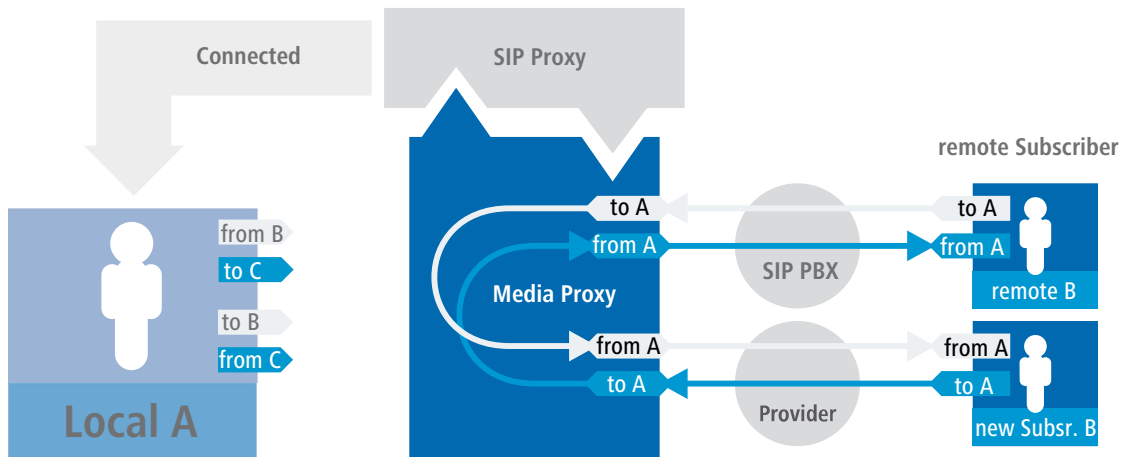

Management of media streams in case of an upstream SIP PBX

Even for two subscribers in the same network behind the LANCOM VoIP router, when connected to an upstream SIP PBX the media proxy generates data streams with separate media end points on the LAN side and on the WAN side (towards the SIP PBX).

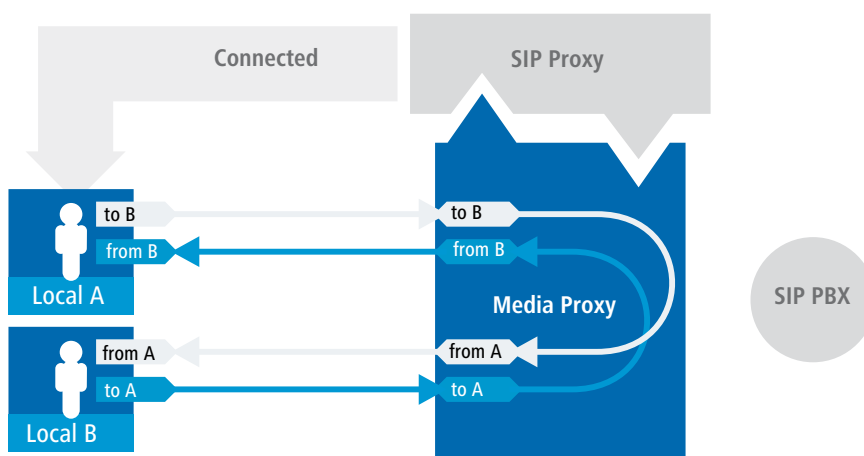

In this case it is not necessary to pass the media streams through the upstream PBX, so the SIP signaling helps the LANCOM VoIP router to make a new decision about the path to be taken by the connection data. Using the end points in the media proxy the data streams can be connected directly, making a diversion via the SIP PBX unnecessary.

This decision is also made again in the media proxy if a local and an external subscriber are connected in such a way that, ultimately, two local subscribers are connected to one another. The media proxy re-assigns the end points when making the connection, so enabling the direct transmission of the data streams between the local participants.

Managing the media streams in the firewall

The media streams are monitored in the firewall as a matter of principle. A firewall rule is generated for each media stream (audio, video). This rule opens a connection for the corresponding IP addresses and ports for each side (LAN-WAN) and carries out a translation according to the IP-port relationships as specified by the media proxy.

Automatic QoS rules for media streams

The QoS mechanism in the firewall reserves the maximum possible amount of connection bandwidth as agreed during the SDP negotiation (SDP, Session Description Protocol) and the packets are prioritized accordingly.

Handling subscribers using different codecs

When connecting different subscribers, the situation can arise where the codecs available to the subscribers do not match together—there are no common codecs due to the SDP negotiation.

The following situations are to be observed here:

- Connections with different media streams, e.g. a video-telephone call (audio + video) and a traditional telephone call (audio only): This connection will be rejected with the message "Codec mismatch".
- Similar media types (audio-audio, video-video) with codecs that do not match: This connection will be rejected with the message "Codec mismatch".

The media proxy can only connect different subscribers if the media type and the codec type match.

1.8 SIP-ID as switchboard number with trunk lines

Until now, SIP trunk lines were given the SIP ID as the switchboard number and modified to suit the telephone number. However, this method is not supported by all trunk-line providers. For this reason you use the SIP mapping table—just like the ISDN mapping—to explicitly define the way that telephone numbers are processed.

Example: With 0123456789# -> # the extension numbers of the trunk are mapped 1:1 to the internal telephone numbers.

1.9 Switching at the SIP provider

When switching external SIP connections, the Call Router in the LANCOM VoIP router generally manages the connection for the full duration of the call. This means that the Call Router retains control over a call even when two external subscribers have been connected to one another and the local subscriber on the LANCOM VoIP router side has ended the call. In this case, the LANCOM VoIP router continues to take up bandwidth for connecting the two external subscribers.

If the connections to the two external subscribers both run via the same SIP provider, an alternative is to transfer the call switching to the provider so that the LANCOM VoIP router stops taking up the bandwidth.

You enable the switching at the SIP provider in the LANconfig under **Voice Call Manager > Lines** by clicking on **SIP lines** and enabling the option **Switching at provider active** on the **General** tab.

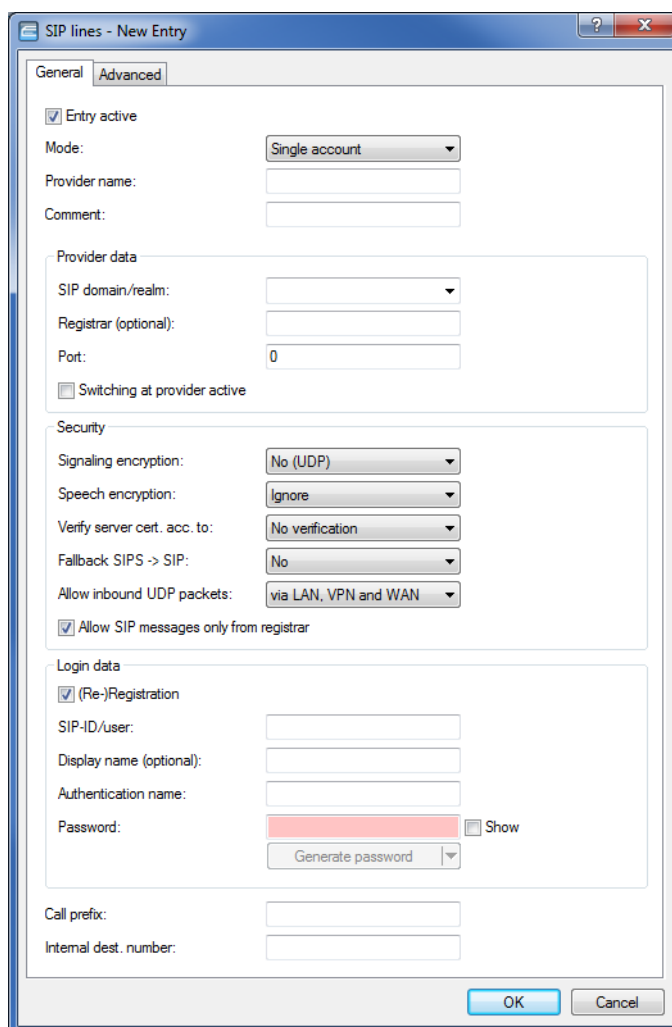

Switching at provider active

Call switching (transfer call) between two remote subscribers can be handled by the device itself (media proxy) or it can be passed on to the exchange at the provider if both subscribers can be reached on this SIP provider

line. The advantage of this is that the LANCOM VoIP router no longer requires the bandwidth. Otherwise, the media proxy in the LANCOM switches the media flows, such as when connecting two SIP provider lines.

 Switching at the provider will only work if both connections are routed via the same provider line.

 An overview of the main SIP providers supporting this function is available in the Support area of our Internet site.

1.10 SIP Application Layer Gateway (SIP ALG)

SIP is increasingly becoming established as the basis for modern real-time communication in IP networks. Unified Communications (UC) and collaboration, IP telephony, video streaming, camera surveillance, intercoms, paging systems, and audio recordings increasingly rely upon SIP and RTP for switching and transmission.

The NAT (Network Address Translation) typically carried out by the access router at the edge of the LAN presents a barrier to SIP communications. This is because of the addresses transmitted during SIP signaling and also because of the dynamically negotiated media sessions and the UDP-based RTP connections that depend upon them.

Restrictive firewall configurations prevent communications even where client/server-side mechanisms such as STUN, ICE and TURN are used to overcome NAT.

The SIP ALG for LCOS detects SIP connections and the RTP-based media streams that they depend upon and transforms these in line with the NAT rules in the access router.

Also, the SIP ALG monitors the bandwidths of the SIP connections and so provides QoS.

1.10.1 Properties

The SIP ALG for LCOS has the following features:

> **No local registration**

The SIP proxy does not provide registration for SIP endpoints. Instead, it mediates the registrations directly to the approved SIP domains.

 This means that it is impossible to set up a line backup over alternative voice lines (analog, ISDN).

> **Transparency for SIP extensions**

The SIP ALG also transmits unknown, non-standard header elements to enable the SIP messages to be communicated between terminal devices and SIP PBXs.

 The SIP ALG determines an unambiguous destination for every SIP message. Forking (communication between multiple devices of the same identity) is handled upstream. The SIP ALG merely provides transparent forwarding of these data packets.

1.10.2 Configuration

Activate and configure the SIP Application Layer Gateway (SIP ALG) in LANconfig under **Miscellaneous Services > Services > SIP Application Layer Gateway**.

 The SIP ALG is disabled in the default settings.

SIP Application Layer Gateway

SIP-ALG activated

Ignore rejecting firewall rules for forwarded SIP packets

SIP-ALG activated

Activate the SIP Application Layer Gateway here.

Ignore rejecting firewall rules for forwarded SIP packets

Here you determine whether the firewall for SIP packets respects Reject rules or whether the packets are forwarded by the SIP ALG in any case.

1.11 Restricting or preventing SIP registration over WAN

To restrict or prevent the SIP registration at the Voice Call Manager over a WAN connection, navigate to **Voice Call Manager > Users** and click the button **SIP users**. The SIP users configuration dialog features a parameter that controls this. You can enable access via VPN, or prohibit it completely.

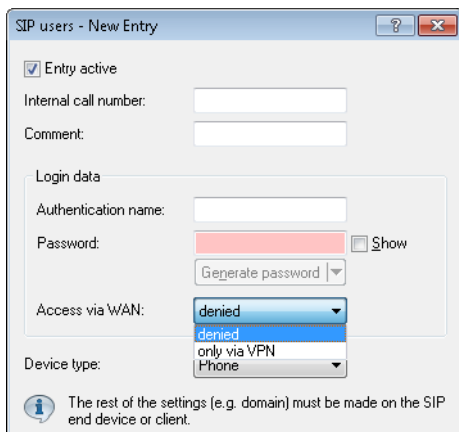

Additional security for the registration is provided by a count of the number of times that a SIP user authenticates incorrectly. Once the counter reaches a threshold value, the device locks the SIP user's account for a certain time. During this period the SIP user cannot log on to the Voice Call Manager. You set the threshold value and the locking time under **Voice Call Manager > General** in the section **WAN login lock**.

WAN login lock

Lock configuration after: login failures

Lock configuration for: minutes

1.12 Certificates for encrypted telephony

You have the option to download certificates for encrypted telephony onto your device and to check whether the existing certificate used by the SIP server to establish a TLS connection should be classified as trustworthy and accepted.

Download the required SIP certificate to your device with LANconfig by navigating to **Configuration management > Upload certificate or file** .

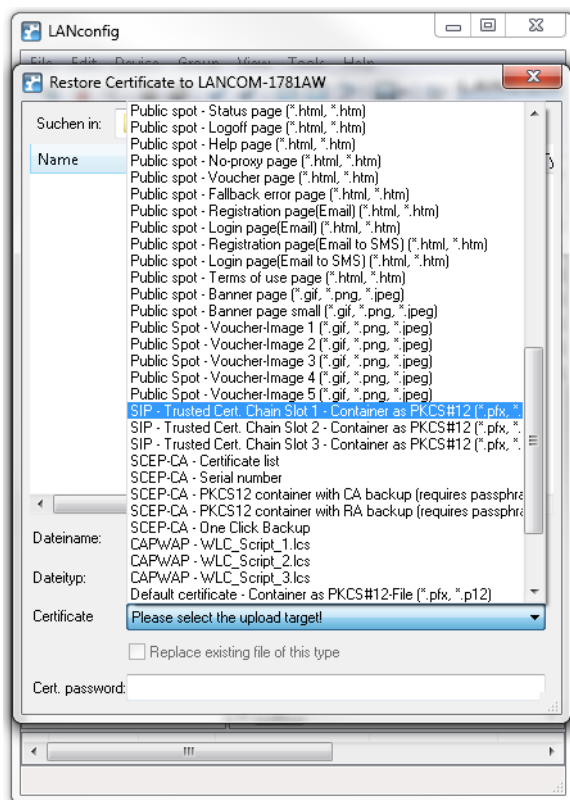

In the LANconfig dialog under **Voice Call Manager > Lines > SIP lines**, select how the SIP certificate is to be checked in the "Security" section:

Security

Signaling encryption: No (UDP) ▼

Speech encryption: Ignore ▼

Verify server cert. acc. to: No verification ▼

Allow SIP messages only from registrar

Verify server cert. acc. to:



With this setting, you specify whether the certificate of the SIP server is verified against certain Certificate Authorities (CAs). CA certificates from globally recognized certificate chains are updated with LCOS updates. They can also be manually updated by truststore updates.

Server certificate

No verification

The server certificate is not verified. All valid server certificates are accepted, whichever CA they were signed by. This setting is useful for accepting self-signed certificates.

Server certificate

All trusted CAs	The server certificate is verified against all CAs known to the device. These include all CAs that LCOS "knows" to be trusted and also those from the VoIP server certificate slots 1 to 3.
	 The encrypted connection is only established if one of these certificates is validated successfully.
VoIP cert. slot 1	A check is made to see whether the server certificate was signed by the CA whose certificate was uploaded to slot 1 of the VoIP certificates.
VoIP cert. slot 2	A check is made to see whether the server certificate was signed by the CA whose certificate was uploaded to slot 2 of the VoIP certificates.
VoIP cert. slot 3	A check is made to see whether the server certificate was signed by the CA whose certificate was uploaded to slot 3 of the VoIP certificates.
Telekom-Shared-Business-CA4	With this setting, the device only accepts server certificates signed by the Telekom Shared Business CA4 CA.
	 Use this setting for SIP trunk connections from Deutsche Telekom.

1.13 Handling canonical telephone numbers

Canonical telephone numbers (familiar from mobile phones and starting with +) were formerly automatically reformatted into standard telephone numbers. + was converted to 00.

In WEBconfig under **Extras > LCOS menu tree > Setup > Voice-Call-Manager > Convert-Canonicals** you can deactivate automatic conversion by setting **no**, in which case the canonical numbers are processed by the call-routing table. This allows you to specify your own lines for canonical numbers, for example.

1.14 Processing Destination Domains

As the VoIP implementation in the LANCOM VoIP router handles all calls as SIP calls, telephone numbers and SIP subscribers contain domain information. Furthermore, SIP numbers can also contain alphanumeric characters.

The SIP domains are used in LCOS as follows:

- > When SIP subscribers register at upstream PBXs or at the LANCOM VoIP router itself.
- > When SIP subscribers establish a connection.

LCOS supports the following defined domains:

- > ISDN for the ISDN interfaces
- > All domains that are entered for the lines

1.14.1 Registration at upstream exchanges

Local SIP subscribers can only register using the domains that are known. The subscribers authenticate themselves at the local LANCOM VoIP router with their user name and password. This excludes domains that correspond to an upstream SIP PBX. These registrations are authenticated at the upstream SIP PBX.

If a subscriber tries to register with an unknown domain, then this may be accepted as a local registration.

1.14.2 Switching internal calls

For internal connections, internal numbers are generally assigned unambiguously. However, SIP telephones, for example, can register with several "lines", such as '1011@provider.com' and '1011@isdn.com', so that a line can be assigned specifically to the required connection.

With internal switching, an attempt is made to find a subscriber whose number and domain match. Only if this was not successful is the call placed using the destination number only. The domain remains unchanged.

For example, calls that are incoming via ISDN (from calling party id@isdn) are switched to subscriber 1011 (to 1011@isdn). The call to the SIP telephone is displayed on the ISDN line key. If there is no such subscriber with such a domain, then the call is delivered to the first known subscriber '1011'.

1.15 Configuring the ISDN interfaces

LANCOM VoIP routers are equipped with multiple ISDN interfaces, which can be used either to connect the device to an ISDN exchange line or to ISDN terminal equipment.

ISDN-TE interface ("external ISDN line")

An ISDN interface in TE mode for connection to the ISDN bus of an upstream ISDN PBX or to an ISDN NTBA. This ISDN interface can be used for backup connections over ISDN or as a dial-in interface for remote sites.

ISDN-NT interface ("internal ISDN line")

With its ISDN interface in NT mode, the LANCOM VoIP router itself provides an internal ISDN bus. This ISDN interface can be used to connect ISDN PBXs or ISDN telephones.

Ex-factory each ISDN interface is set to TE mode. A cross-over adapter (shipped with the All-IP option) converts it to an NT port. With LANCOM business VoIP routers, this function is controlled via LCOS.

- Multiple TE interfaces provide, for example, up to four B channels as a backup or for dial-in.
- With multiple NT interfaces, for example, a downstream ISDN PBX provides up to eight B channels.

Depending on the combination of ISDN interfaces in TE and NT mode, you need to set up the bus termination, and the appropriate protocol needs to be set in the software. The setting for the protocol allows for the type of ISDN connection to be used (point-to-multipoint or point-to-point).

1.15.1 Point-to-multipoint and point-to-point connections

LANCOM VoIP routers support point-to-multipoint and point-to-point connections:

- Point-to-multipoint connection (point-to-multipoint): Up to 8 ISDN terminal devices can be connected to this type of connection. Terminal equipment can include ISDN telephones and ISDN PBXs, which can be used for connecting yet more equipment. As an alternative, a LANCOM VoIP router can be connected to a point-to-multipoint connection.
- Point-to-point connection (point-to-point): This type of device is suitable for the connection of one ISDN device only, generally an ISDN PBX. As an alternative, a LANCOM VoIP router can be connected to a point-to-point connection.

To connect a LANCOM VoIP router, the interface is set up for the type of line at hand.

Equipment connected to an ISDN connection can be addressed in two ways:

- The devices are addressed with a multiple subscriber number (MSN) that is linked to the ISDN connection and cannot be influenced.

- Terminal devices are addressed via a Direct Dialing In-Number (DDI). However, only the switchboard number is associated with the telephone line; the extension numbers that address the individual terminal devices can be chosen at will and are merely suffixes to the switchboard number. The switchboard number, extension and area selection code (not including the leading zero) can be at the most 11 characters long.

 The terms "point-to-multipoint connection" and "point-to-point connection" are used in many countries to describe the technical implementation of point-to-multipoint with MSN and point-to-point with DDI. Other countries may use different types of connection and other combinations of protocol and call-number type, or even different names. Please refer to your telephone network operator for the technical specifications of your ISDN connection.

1.15.2 Bus termination

The configuration of the bus termination is either done in the software or, as is the case with the All-IP option, by using the supplied cross-over adapter.

 Bus termination is obligatory with an ISDN interface in NT mode.

Bus termination is generally deactivated for ISDN interfaces in TE mode. If the LANCOM VoIP router is the last device at a longer ISDN bus and this itself is not terminated, it may be advantageous to activate the bus termination for an ISDN interface in TE mode.

1.15.3 Protocol settings

In LANconfig, parameters for the ISDN interfaces are entered in the configuration section 'Interfaces' under 'WAN'. In WEBconfig, Telnet or an SSH client you find the settings for the ISDN interface parameters under `Setup/Interfaces/WAN`.

Select the protocol for each ISDN interface according to its application and the ISDN connection type: Point-to-multipoint and point-to-point connections can be used in various combinations with a LANCOM VoIP router. The following options are available:

- **Automatic** for automatic selection of the operating mode (only in TE mode)
- **DSS1 TE (Euro ISDN)** for connection to a point-to-multipoint ISDN bus.
- **DSS1 TE point-to-point** for connection to a point-to-point ISDN bus.
- **1TR6 TE (German ISDN)** for connection an ISDN bus which uses this protocol (in Germany only).
- **DSS1 NT (Euro ISDN)** to provide point-to-multipoint ISDN interfaces
- **DSS1 NT reverse** to provide point-to-multipoint interfaces while maintaining the ISDN timing of the connected ISDN line.
- **DSS1 NT (point-to-point)** to provide point-to-point ISDN interfaces
- **DSS1 NT point-to-point reverse** to provide point-to-point interfaces while maintaining the ISDN timing of the connected ISDN line.
- **DSS1 timing** to maintain the ISDN timing of the connected ISDN line.
- **Off**

 If an ISDN device is attached to an ISDN interface that is set to auto and is not recognized properly, set the required protocol manually.

1.15.4 ISDN connection timing

To ensure trouble-free transmission, all of the components in the ISDN system (LANCOM VoIP routers, upstream and downstream ISDN PBXs and ISDN terminal devices) have to use the same ISDN timing. In the LANCOM VoIP router, an ISDN interface in TE mode can take on the timing of the ISDN line. The TE interface enables the device itself to behave like a terminal device. In NT mode, the LANCOM VoIP router can pass on the on this timing over the ISDN interfaces to

any connected terminal equipment or downstream ISDN PBXs. The NT interface enables the device itself to behave like an exchange.

A number of ISDN interface settings are available for specifying the ISDN interface which is to supply the ISDN timing to the LANCOM VoIP router, which in turn passes on the timing to the devices at the NT interfaces.

- **Automatic:** If no interface has been manually selected for the timing, the device automatically searches for a TE interface to supply the timing. To ensure that the timing is synchronous, the TE connectors constantly try to keep the connection activated. This ensures that the timing continues to be supplied even if one of multiple TE lines should be shut off. If none of the TE connectors supply a timing, then the timing system runs "freely" and uses the internal timing of the LANCOM VoIP router.
- **DSS1 timing:** This setting takes on the ISDN timing from this connection, and this is used by the LANCOM VoIP router and further devices connected over the NT interface. In this way, the timing can be switched through in parallel to an existing ISDN PBX at a point-to-point connection. Apart from passing on the ISDN timing, the interface is not active.
- **DSS1 NT reverse** or **DSS1 NT point-to-point reverse:** When all ISDN interfaces are operated in NT mode, the timing system runs "freely" because there is no TE interface to take on the ISDN timing. If in this case the ISDN connections are connected, for example, to an ISDN PBX which is being supplied with ISDN timing from another source, then interference to the transmission may arise because the timing of the LANCOM VoIP router is not synchronous to that of the PBX. In such cases, the reverse setting allows the ISDN timing to be taken from an NT-mode interface, so ensuring that the LANCOM VoIP router runs synchronously with the overall system.

1.16 Configuration examples

1.16.1 VoIP telephony in stand-alone operation

This example shows how to configure a LANCOM which is used as a central device for Internet connectivity and VoIP telephony at a new site.

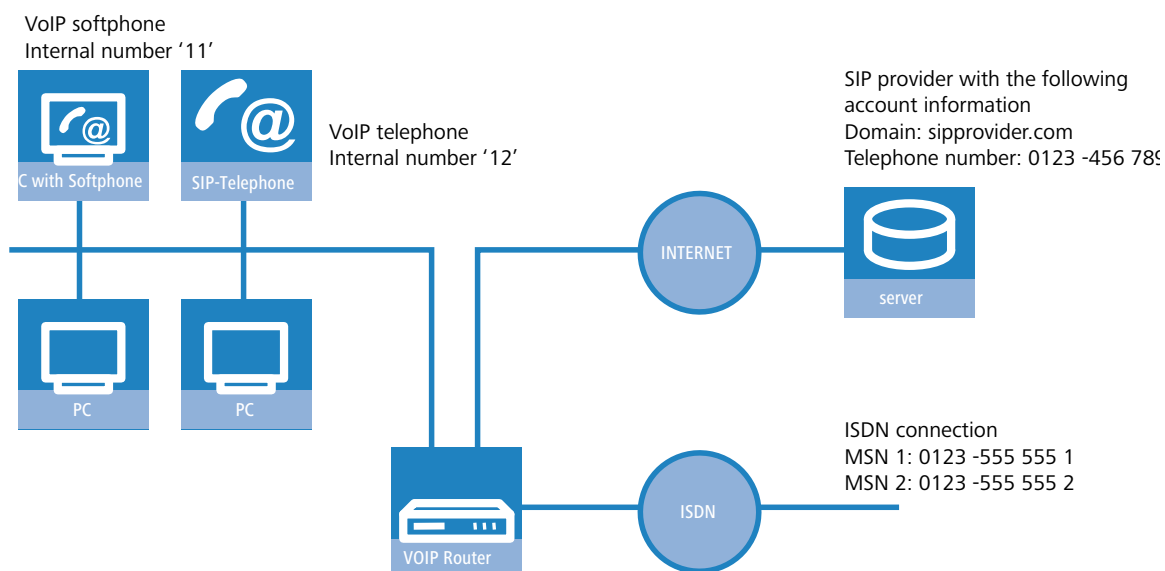

Objective

- Internal telephony with SIP telephones and SIP softphones.
- Access to internal terminal equipment via the MSNs.
- External telephony via the SIP provider with backup over ISDN.

- Calls to emergency and service numbers via ISDN.

Requirements

- LANCOM connected to the LAN and WAN, an ISDN TE interface is linked to the ISDN NTBA. The Internet connection has been set up.
- A dialing plan with a unique internal telephone number for all terminal equipment to be connected, here, for example, the number 11 for the VoIP softphone and the number 12 for the VoIP telephone.
- A SIP provider account.

Using the information during configuration

The following table provides a summary of the information required for configuration and where it can be entered. SIP terminal equipment parameters can be entered using the SIP telephone keypad, the corresponding configuration software, or the softphone configuration menu.

	LANCOM	SIP terminal equipment	ISDN PBX	ISDN terminal equipment
Internal VoIP domain	✓	✓		
Internal numbers	✓	✓	✓	✓
External SIP telephone number	✓			
SIP account access data	✓			
External ISDN telephone numbers (MSNs)			✓	
Country and local area code	✓			

Configuring the device

The following steps are required to configure the device:

- Set up the line to the SIP provider
- Enable the ISDN interface, and assign MSNs to the internal numbers

 In this example, it is not necessary to configure SIP users: The SIP users are authenticated at the LANCOM with the settings created in the terminal equipment (softphone and VoIP telephone).

Configuring the device in detail:

- Under LANconfig, start the setup wizard for configuring the Voice Call Manager. Enable the options **SIP provider** and **ISDN phone system**.

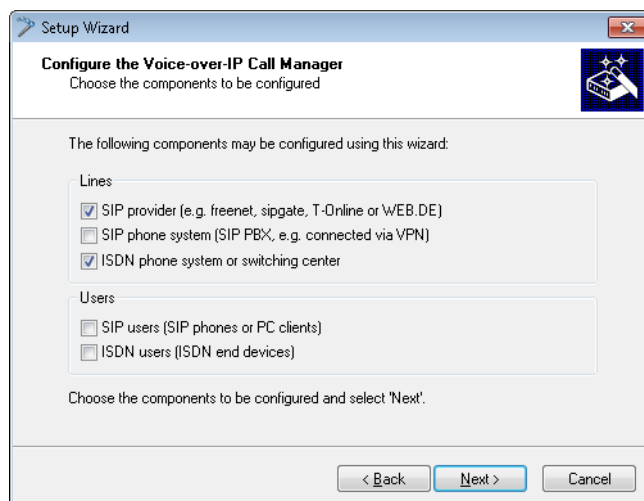

- Enter a unique domain for the local VoIP domain which describes the local VoIP area for the site (e.g. `mycompany.internal`.)
- Configure the line to the SIP provider, for example with the name `SIPPROVIDER` with the following values:
 - > Internal default number: All calls arriving from the SIP provider are forwarded to this internal number. Enter an internal number from your dialing plan here, e.g. `11`.
 - > SIP domain/realm: You received this domain from your SIP provider; it is usually entered in the format `sipdomain.tld` without the part that designates any specific server.
 - > Registrar (FQDN / IP) (optional):
 - > Outbound proxy (optional):
 - > SIP-ID / user: Enter the SIP number with local area code here, providing that the SIP provider does not require any other information.
 - > Display name (optional): The display name is only required if the SIP provider verifies this during registration. If you enter a display name here, then this name will be displayed at the remote site. If the field remains empty, then the display name for the corresponding internal user is transmitted.
 - > Authentication name (optional): Special authentication names are not supported by all SIP providers. In many cases, the authentication name is the same as the SIP ID or the user name. Complete this field only if your SIP provider has issued you a special authentication name.
 - > Password: Enter the password for SIP access here.

 This description applies to a "user-defined configuration". If you select a special SIP provider from the list, then some of the parameters will be preconfigured automatically.

- Configure an ISDN line for VoIP telephony use. For every MSN on your ISDN connection, make an assignment to an internal number within your telephone number plan during ISDN mapping.
 - > MSN 1 555 555 1 / internal phone number 11
 - > MSN 2 555 555 2 / internal phone number 12
- Enter the local and national area code for the device's location. Using this information, the Voice Call Manager can decide whether or not outgoing calls are local calls, national or international long distance calls.

6. Based upon the entries made so far, LANconfig creates a suggestion for the call routing table which you can adapt to fit your requirements as follows:

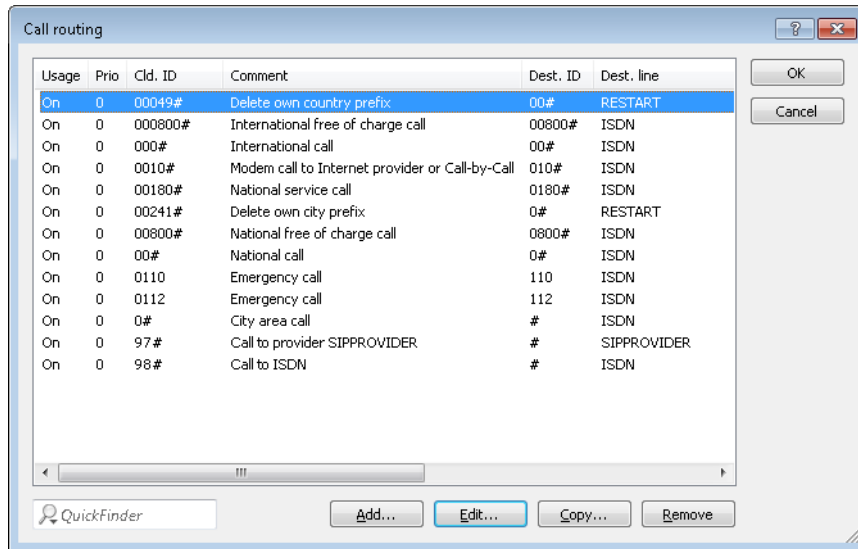

- ! The # sign is a placeholder for any character string. The entry 0# is therefore suitable for all numbers dialed that have at least one 0 preceding them.

This suggested call routing table would place all external calls over the ISDN line. The SIP line is set up as a backup for international and national long distance calls and local calls that are not in the list of special or emergency numbers.

Call routing - New Entry

Entry active / default line: Active

Priority: 0

Called number: 000#

Comment: International call

Mapping

Destination number: 00#

Destination line: SIPPROVIDER

If the line is not available, you can define additional destinations here.

2. dest. number: 00#

2. dest. line: ISDN

3. dest. number:

3. dest. line:

Filters

In addition to the called number you can define further filters for this entry:

Called domain:

Calling number:

Calling domain:

Source line:

In order to channel calls to special destinations, such as international and national long distance calls, over the SIP provider, double-click on the corresponding entry in the table and switch the line used from ISDN to SIPPROVIDER.

Don't forget to switch the backup line from SIP to ISDN, if necessary! After being adapted for international and national long distance, the call routing table should appear as follows:

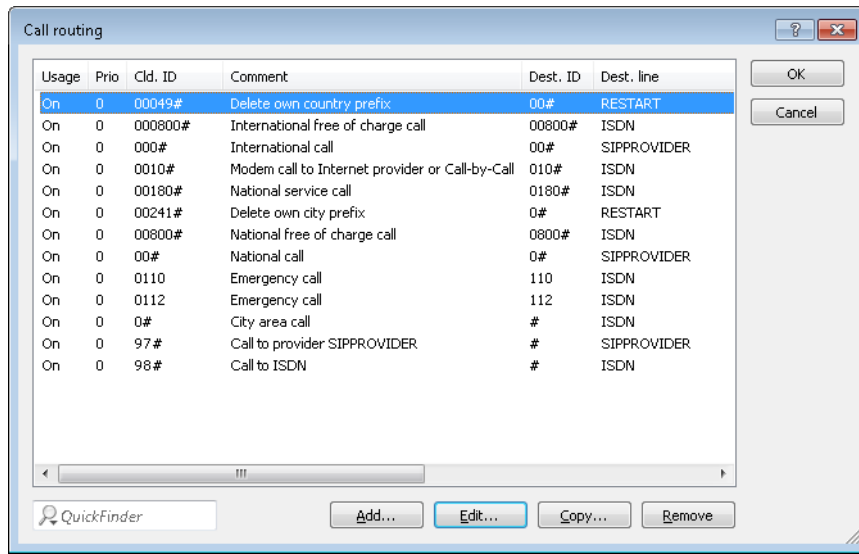

Configuring the VoIP terminal equipment

Enter the registration information for the first SIP user in the softphone.

Call routing procedure for outgoing calls

On outgoing calls, the Call Manager first searches the call routing table from top to bottom. If the Call Router cannot find a matching entry there, it uses the list of registered users:

	User	Dials	Correct call route	Correct user	Mapping, number in use	Destination line
1	VoIP telephone	11	None	VoIP softphone	11	Internal
2	VoIP telephone	0 555 555	3 0#		0241 #: 0241 555 555	ISDN
3	VoIP telephone	0 0123 666 666	3 00#		0 #: 0123 666 666	SIP provider

1. The Call Manager cannot find an entry that corresponds to 11 in the call routing table. Now it searches the list of registered users and finds the internal SIP user there.

Call routing uses not just the users configured in the LANCOM, but all of the users that are actually authorized with the call router. This allows SIP users to authenticate with the call router even if they are not entered in the LANCOM. The entry of the internal VoIP domain on the LANCOM is sufficient for authentication, assuming that local authentication is not required.

2. The entry 3 in the call routing table shown above matches the dialed number. The call router removes the 0 outside-line access prefix, adds the area code for the local telephone network and makes the call to 0241 555 555 via the ISDN line.

The area code for the local telephone network is added on because calls via SIP providers usually require the area code to be dialed.

3. The entry in the call routing table is suitable in this case. The call router removes the 0 prefix for access to the outside line and completes the call to 0123 555 555 via the SIP line. If the SIP line is not available, then the call is made over the ISDN line.

Call routing procedure for incoming calls

For incoming calls, the telephone network exchange removes the prefix from the number dialed (destination number). Therefore, the LANCOM only receives the number itself, which may be treated differently depending on the source:

- > Numbers from the ISDN network are translated with the ISDN mapping table to the internal number which is entered for the receiving MSN.
- > Calls from a SIP network are mapped to the internal destination number entered for the corresponding SIP line.

With the altered number, the Call Manager begins to search the call routing table from top to bottom. If the Call Router cannot find a matching entry there, the call is forwarded directly to the internal number:

	Remote site dials	Call router receives	Assigned via	Number in use	Correct call route	Destination line
1	0 123 456 789	456 789	internal destination number for SIP line	11	None	Internal
2	0 123 555 555 1	555 555 1	ISDN mapping	11	None	Internal
3	0 123 555 555 2	555 555 2	ISDN mapping	12	None	Internal

1.16.2 Using VoIP telephony to enhance the upstream ISDN PBX

This example shows how to configure a LANCOM when an upstream ISDN PBX is enhanced with the VoIP telephony capability. Until now, the MSNs 11 to 13 for the ISDN connection have been used for two ISDN telephones and one analog fax.

-  The PBX is configured so that subscribers dial 0 to access an outside line.

The LANCOM is operated on an ISDN PBX extension line.

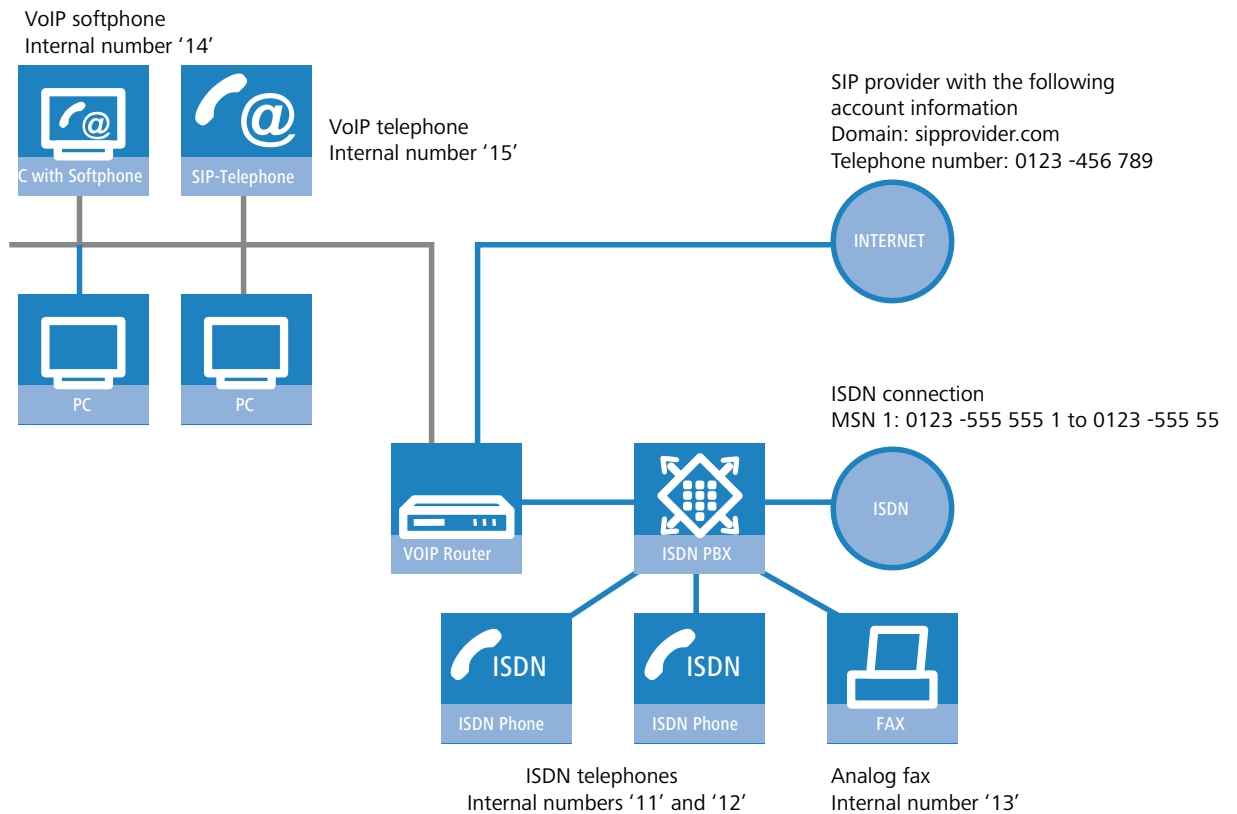

Objective

- > Internal telephony with ISDN and SIP telephones and SIP softphones.
- > External telephony with VoIP terminal equipment via the SIP provider with backup over ISDN.
- > External telephony with ISDN terminal equipment in the PBX. Depending on the functionality of the ISDN PBX, ISDN terminal equipment can also use the SIP lines in the LANCOM VoIP router.
- > Accessing internal terminal equipment (ISDN and SIP) via the MSNs.
- > Calls to emergency and service numbers via ISDN.

Requirements

- > LANCOM connected to the LAN and WAN; an ISDN TE interface is linked to the extension interface on the ISDN PBX. The Internet connection has been set up.
- > A dialing plan with a unique internal telephone number for each piece of terminal equipment to be connected. In general, the numbers used are predetermined by the PBX, which often only allows certain number ranges.
- > A SIP provider account.

Using the information during configuration

Dialing plans with ISDN PBX systems: When crossing from the ISDN network to the internal subscribers, the ISDN PBX converts the external MSNs to internal MSNs. When operating a LANCOM VoIP router at the extension interface of the ISDN PBX, the internal MSNs of the PBX are translated to the internal numbers of the VoIP range. For reasons of clarity, we recommend using congruent internal MSNs/numbers for terminal equipment for all connections.

The following table provides a summary of the information required for configuration and where it can be entered. SIP terminal equipment parameters can be entered using the SIP telephone keypad, the corresponding configuration software, or the softphone configuration menu.

	LANCOM	SIP terminal equipment	ISDN PBX	ISDN terminal equipment
Internal VoIP domain	✓	✓		
Internal numbers	✓	✓	✓	✓
External SIP telephone number	✓			
SIP account access data	✓			
External ISDN telephone numbers (MSNs)			✓	
Country and local area code	✓			

Configuring the device

The following steps are required to configure the LANCOM:

- Set up the line to the SIP provider
- Enable the ISDN interface and the mapping of internal MSNs in the PBX to the internal numbers of the LANCOM VoIP router
- Adapt the call-routing table

ⓘ In this example, it is not necessary to configure SIP or ISDN users:

- The SIP users are registered at the LANCOM with the settings in the terminal equipment (softphone and VoIP telephone).
 - The ISDN devices can be reached via a corresponding entry in the call routing table.

Configuring the LANCOM in detail:

1. Under LANconfig, start the setup wizard for configuring the Voice Call Manager. Enable the options **SIP provider** and **ISDN phone system or switching center**.

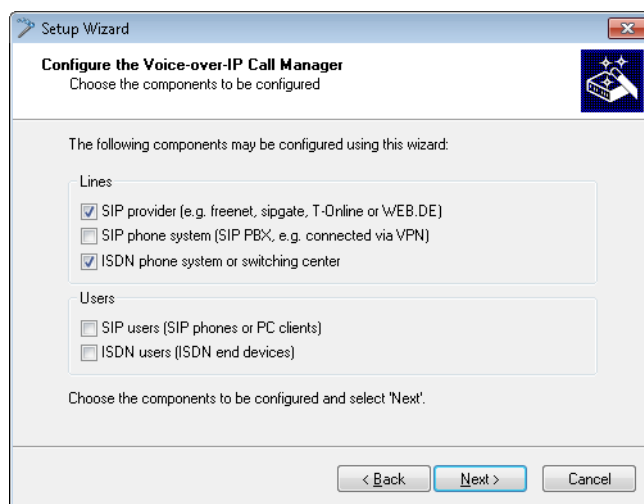

2. Configure the device as described in the preceding examples:

Unique local VoIP domains

A line to a SIP provider

ISDN line

- Adapt the suggested call routing table in order to direct calls to service numbers automatically over the SIP provider's line. The following example shows the entry for international calls.

Call routing - New Entry

Entry active / default line: Active

Priority: 0

Called number: 000#

Comment: International call

Mapping

Destination number: 00#

Destination line: SIPPROVIDER

If the line is not available, you can define additional destinations here.

2. dest. number: 000#

2. dest. line: ISDN

3. dest. number:

3. dest. line:

Filters

In addition to the called number you can define further filters for this entry:

Called domain:

Calling number:

Calling domain:

Source line:

1. After adaptation, the call routing table appears as follows:

Usage	Prio	Cld. ID	Comment	Dest. ID	Dest. line
On	0	00049#	Delete own country prefix	00#	RESTART
On	0	000800#	International free of charge call	00800#	ISDN
On	0	000#	International call	00#	SIPPROVIDER
On	0	0010#	Modem call to Internet provider or Call-by-Call	010#	ISDN
On	0	00180#	National service call	0180#	ISDN
On	0	00241#	Delete own city prefix	0#	RESTART
On	0	00800#	National free of charge call	0800#	ISDN
On	0	00#	National call	0#	SIPPROVIDER
On	0	0110	Emergency call	110	ISDN
On	0	0112	Emergency call	112	ISDN
On	0	0#	City area call	#	ISDN
On	0	97#	Call to provider SIPPROVIDER	#	SIPPROVIDER
On	0	98#	Call to ISDN	#	ISDN

The leading 0 is removed from the number for long distance calls, and the call is made via the SIP provider.

2. For ISDN calls, however, the 0 should not be removed from the destination number because the upstream ISDN PBX requires the 0 to access an outside line. Therefore, adapt the destination number for all entries with the destination line 'ISDN'.

After adaptation, the call routing table appears as follows:

Usage	Prio	Cld. ID	Comment	Dest. ID	Dest. line
On	0	00049#	Delete own country prefix	00#	RESTART
On	0	000800#	International free of charge call	000800#	ISDN
On	0	000#	International call	00#	SIPPROVIDER
On	0	0010#	Modem call to Internet provider or Call-by-Call	0010#	ISDN
On	0	00180#	National service call	00180#	ISDN
On	0	00241#	Delete own city prefix	0#	RESTART
On	0	00800#	National free of charge call	00800#	ISDN
On	0	00#	National call	0#	SIPPROVIDER
On	0	0110	Emergency call	0110	ISDN
On	0	0112	Emergency call	0112	ISDN
On	0	0#	City area call	#	ISDN
On	0	97#	Call to provider SIPPROVIDER	#	SIPPROVIDER
On	0	98#	Call to ISDN	#	ISDN

3. In order to allow the ISDN subscribers to be contacted internally by the VoIP users, a default route is also set up which directs all calls that have not yet been resolved to the ISDN line without changing the numbers.

After adaptation, the call routing table appears as follows:

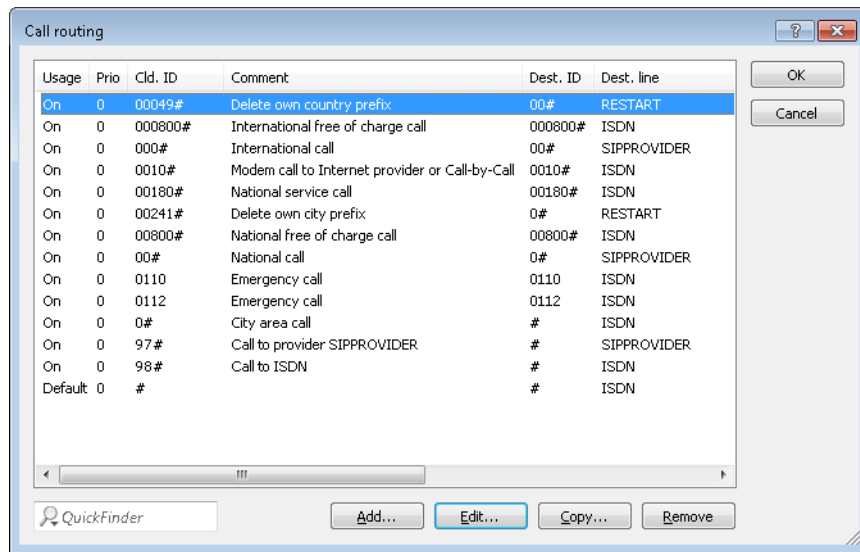

i This call routing table is only valid for PBX systems where the subscribers dial 0 to access an outside line. If the PBX uses another mechanism for accessing an outside line, then the table must be adapted accordingly.

Configuring the VoIP terminal equipment

The VoIP terminal equipment is configured as described in the preceding examples with internal VoIP domains and internal numbers for the local site.

Configuring the ISDN PBX

When configuring the PBX, external MSNs are assigned to internal MSNs. For every VoIP terminal device, a free internal MSN is linked to an external MSN.

External and internal calls from ISDN terminal devices into VoIP telephony

First, the ISDN terminal devices forward the desired destination number to the ISDN PBX when the call is being established. If the number is an internal number/MSN, then the PBX directs the call to the internal ISDN bus. The SIP terminal equipment connected to the LANCOM can only be reached by an internal call if the PBX knows the internal number for the VoIP user.

If your PBX is able to direct external numbers to the internal ISDN bus, then the ISDN terminal devices can also use the lines configured in the LANCOM, such as the SIP provider line, for outgoing external calls.

Configuring the ISDN terminal equipment

Configuring the ISDN terminal equipment is generally limited to entering the internal MSN used in the PBX.

Call routing procedure for outgoing calls

	User	Dials	Correct call route	Correct user	Mapping, number in use	Destination line
1	VoIP telephone	14	None	VoIP softphone	14	Internal
2	VoIP telephone	11	3 # (default)		#: 11	ISDN
3	ISDN telephone	14	1. PBX	VoIP softphone	14	Internal

	User	Dials	Correct call route	Correct user	Mapping, number in use	Destination line
4	VoIP telephone	0 555 555	2 0#		00241#:0 555 555	ISDN
5	ISDN telephone	0 555 555	1. PBX		555 555	ISDN exchange
6	VoIP telephone	0 0123 666 666	1 00#		0#:0123 666 666	SIP provider

- Internal call between two VoIP terminal devices.
- Internal call from VoIP to ISDN. In the first pass (without the default routes) the number 11 does not match any of the routes. Similarly, no matching entry is found in the list of authenticated users. In the second pass, the default route finds # (entry 3 in the call routing table shown above) and directs the call **unchanged** to the ISDN line. The PBX receives the call on its internal ISDN bus, recognizes the called number as an internal MSN, and again forwards the call to the internal ISDN bus that the respective ISDN terminal device is connected to.
- Internal call from ISDN to VoIP. The ISDN PBX recognizes the destination number 14 as an internal MSN and directs the call to the corresponding internal ISDN bus. The Call Router receives the call to 14, does not find a matching entry in the call routing table but does find an entry in the list of authenticated users.
- External call from the VoIP into the local telephone network. The entry 2 in the call routing table shown above matches the dialed number. The Call Router completes the area code for the local telephone network and sends the call out to the ISDN line. Only now does the SIP PBX removes the 0 outside-line access prefix and makes the call to 0241 555 555 via the ISDN exchange line.
- External call from ISDN into the local telephone network. The ISDN PBX recognizes the destination number as an external destination, removes the 0 outside-line access prefix and completes the call to 555 555 via the ISDN exchange line.
- External call from VoIP into the national telephone network. The entry 2 in the call routing table is suitable in this case. The call router removes the 0 prefix for access to the outside line and completes the call to 0123 555 555 via the SIP line. If the SIP line is not available, then the call is made over the ISDN line. In this case, the 0 is retained in the destination number in order to gain access to an outside line through the PBX.

Call routing procedure for incoming calls

	Remote site dials	Call router receives	Assigned via	Number in use	Correct call route	Destination line
1	0 123 456 789	456 789	internal destination number for SIP line	11	None	ISDN
2	0 123 555 555 1		ISDN PBX	11		Internal
3	0 123 555 555 14 4		1. ISDN PBX 2. List of local users	14	None	Internal

- The incoming call for the SIP line number is directed to the Call Router along with the internal destination number that has been configured. The Call Router cannot find a matching entry in the call routing table, but it can find a registered user with the matching internal number. Since the user is an ISDN user, the Call Router directs the call to the ISDN line. The PBX receives the number 11 and can determine this call to be an internal call for the connected ISDN telephone.
- The incoming calls to the MSNs for the connected ISDN terminal equipment can be assigned directly by the PBX itself, the Call Router is not involved here.

3. The PBX directs incoming calls to the MSNs for the connected VoIP terminal equipment to the internal ISDN bus with the internal MSN. The Call Router receives these calls as if they were internal calls and forwards them to the appropriate user since no corresponding entry can be found in the call routing table here either.

1.16.3 Connecting to an upstream SIP PBX

In this example, a branch office network will be connected to the headquarters network over VPN. In addition to data transfer, the telephone structure in the branch office is also connected to the central SIP PBX. A LANCOM VoIP router is used in the branch office network and a LANCOM VPN router acts as the VPN end point at the headquarters. The telephony subscribers at the headquarters receive internal extensions in the number range 101 to 199; for each of the branch offices, a 10-digit block from the 200 range is reserved - in this example, 211 to 219.

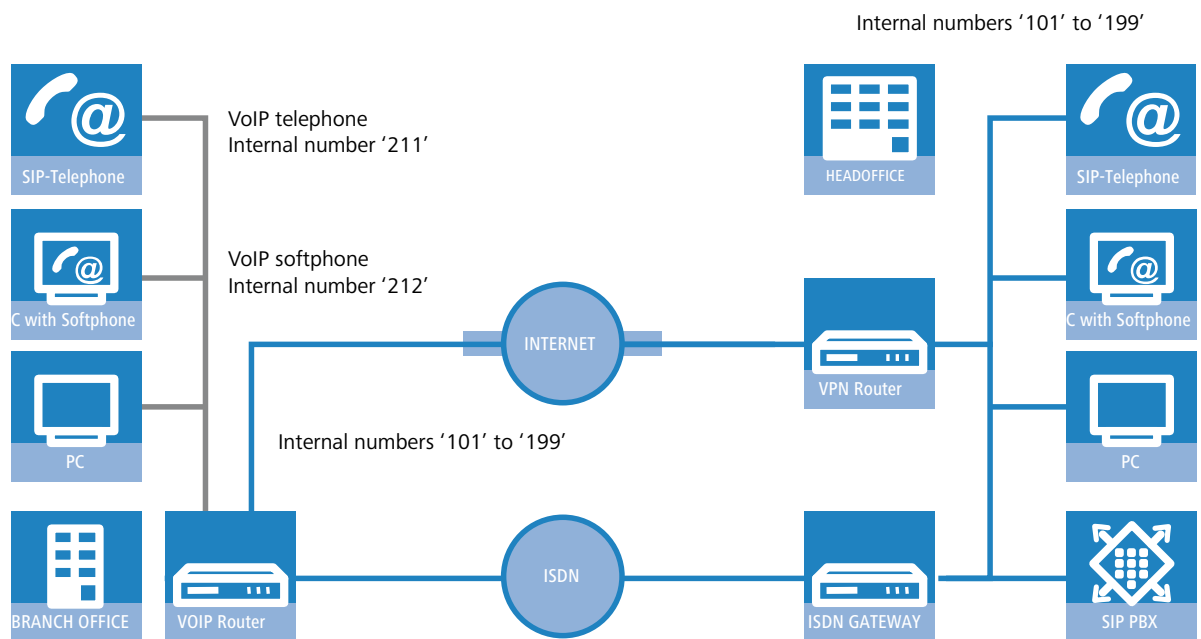

Objective

- > Internal telephony between all locations.
- > External telephony from the branch office via the SIP PBX at the headquarters with backup over ISDN.
- > Calls from the branch office into the local telephone network via ISDN.
- > Calls to emergency and service numbers via ISDN.

Requirements

- > LANCOM connected to the LAN and WAN, an ISDN TE interface is linked to the ISDN NTBA.
- > The Internet connection has been set up by means of a VPN tunnel, as has the network connection between the two locations. All terminal devices can contact one another with the IP addresses used.
- > A dialing plan with a unique internal telephone number for each piece of terminal equipment to be connected.
- > A SIP provider account.

Configuring the device

The following table provides a summary of the information required for configuration and where it can be entered. Basically, all that is needed is a SIP PBX line for each location that is correspondingly setup at the remote location

	LANCOM, branch	SIP phone, branch	SIP PBX, headquarters
Internal VoIP domain	mycompany.BRANCH01	mycompany.HQ	mycompany.HQ

	LANCOM, branch	SIP phone, branch	SIP PBX, headquarters
Internal SIP subscriber numbers at the branch office		✓	✓
External ISDN telephone numbers (MSNs)	✓		
Country and local area code	✓		
SIP PBX line	HQ		
SIP PBX domain	mycompany.HQ		
SIP PBX registration password	✓		✓
Call route	<ol style="list-style-type: none"> 1. Called number 2# 2. Destination line LOCATION_B 3. Destination number 2# 		

Configuring the LANCOM in detail:

1. Under LANconfig, start the setup wizard for configuring the Voice Call Manager. Enable the options **SIP provider** and **ISDN phone system**.

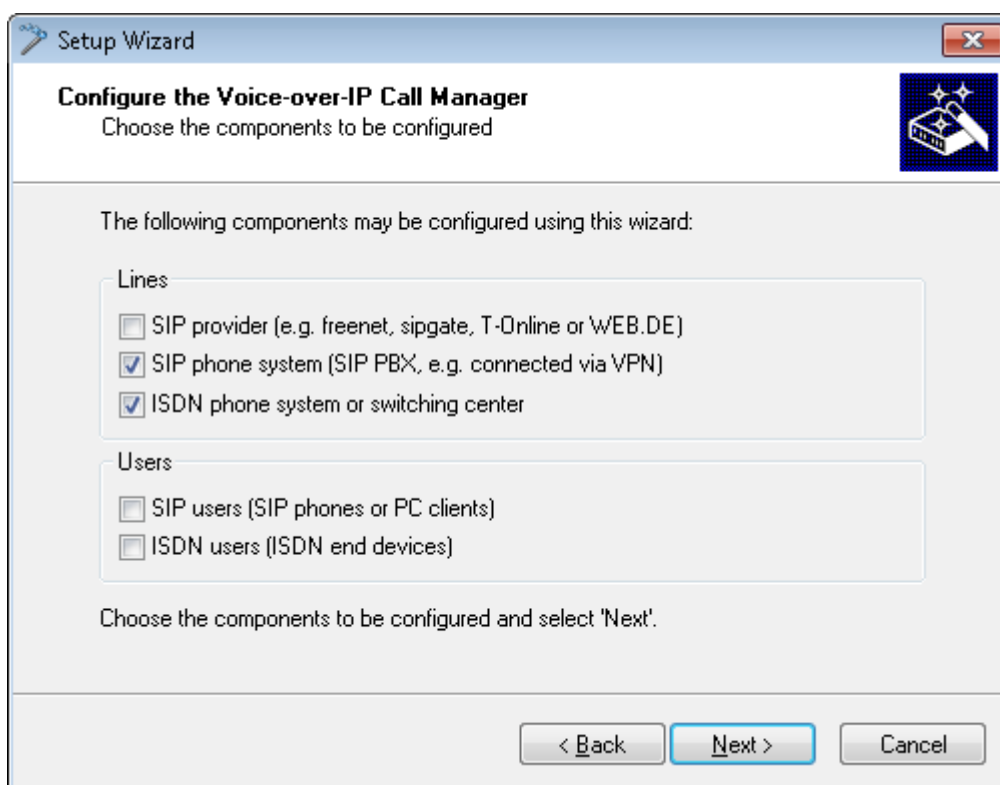

2. Configure the device as described in the preceding examples:
 - > ISDN line with MSN mapping
 - > Area and country code for each location
3. Enter a unique domain for the local VoIP domain which describes the local VoIP area for the branch office, e.g. mycompany.BRANCH01 for the first branch.

4. Configure the line to the SIP PBX with the following values:
 - SIP PBX line name: A unique name for the line to the SIP PBX, for example HQ for "Headquarters".
 - PBX SIP domain/realm: Internal VoIP domain of the SIP PBX, e.g. mycompany . HQ.
 - Registrar (FQDN or IP) (optional): SIP PBX address in the headquarters network, in the event that the device cannot be identified via DNS resolution of the VoIP domain (PBX SIP domain/realm).
-
5. The call routing table suggested by the setup wizard automatically allows international and national long distance calls to be made via the SIP PBX at the headquarters.



Use the IP address of the SIP PBX from the private IP address range at the headquarters as accessed via VPN.

- Outbound proxy (optional): It is generally not necessary to designate the outbound proxy. You only need to enter a server designation here if the SIP PBX requires the corresponding addresses.
- Shared PBX password: This password is used by all SIP users when registering at the SIP PBX. If registration with a shared password is not desired, then an individual password can be used for each SIP user. In this case, each of the SIP users are configured with their own password in the LANCOM.
- Public PBX number: Here, enter the phone number where the SIP PBX can be reached from the public telephone network, e.g. from where the LANCOM is located. The number is entered with the **necessary** prefixes, but without an extension number. For example, if the SIP PBX is located in London and the LANCOM is in Birmingham, then the public PBX number is 020 12345.

In addition, a **default route** is used to direct calls from the LANCOM VoIP users to internal SIP PBX numbers via the corresponding SIP PBX line.



This special entry is only used during the second pass in the call routing table, after the first pass found no corresponding entry for "normal" routes and if no matching internal number was found in the list of local users.

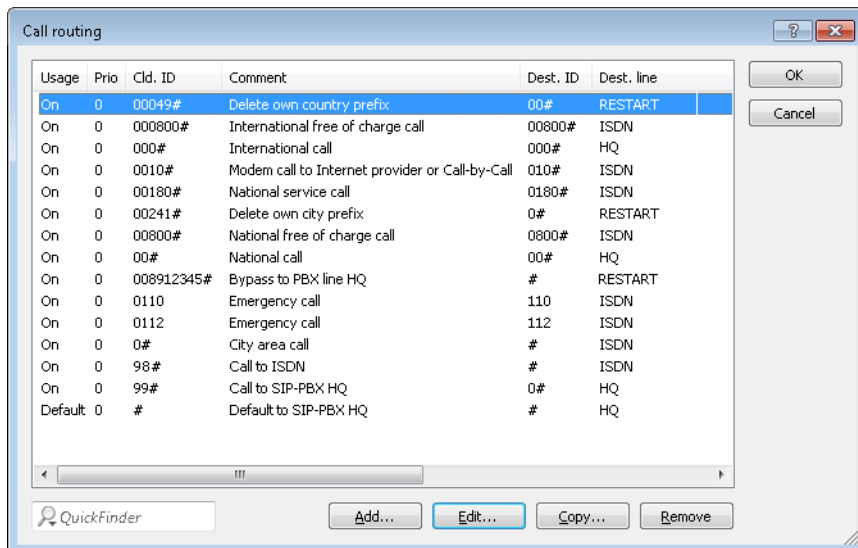

Configuring the VoIP terminal equipment

The VoIP terminal equipment is configured as described in the preceding examples, although in this case the SIP PBX VoIP domain and the internal numbers configured in the SIP PBX are used.

Automatic SIP user authentication at the LANCOM and the SIP PBX.

Using the SIP PBX domain with VoIP terminal equipment registers the user in two ways:

- > Since authentication uses a valid domain defined in the LANCOM, terminal devices are registered as "local users".
- > Since this domain does not correspond to the LANCOM's own VoIP domain, a simultaneous attempt is made to authenticate at the upstream SIP PBX. If the password used corresponds to the password stored in the SIP PBX for this user, then the registration on the SIP PBX will be successful.

Configuring the SIP PBX

In the SIP PBX, all users from the branch office network are entered with their own internal number. For this purpose, either the shared password is entered or a separate password is assigned for each user.

Call routing procedure for outgoing calls

	User	Dials	Correct call route	Correct user	Mapping, number in use	Destination line
1	VoIP phone, branch	212	None	VoIP softphone	212	Internal
2	VoIP phone, branch	199	4 #	SIP subscribers at the headquarters	#: 199	SIP-PBX
3	VoIP phone, branch	0 555 555	3 0#		0241#: 0241 555 555	ISDN
4	VoIP phone, branch	0 0123 666 666	2 00#		00#: 0123 666 666	SIP-PBX

1. Internal call between two VoIP terminal devices at the branch office. The dialed number 212 does not match any of the routes listed in the call routing table. Therefore, the call router searches the local user list, finds the correct entry there and can forward the call internally.
2. Internal call between a VoIP terminal device at the branch office and the internal subscriber 199 at the headquarters. The dialed number 199 does not match any of the routes listed in the call routing table during the first pass. Similarly, no matching entry can be found in the local user list. In the second pass through the call routing table, the default routes are considered too. The route with the called number # (4) corresponds to all calls which could not be assigned earlier. The call to 199 is therefore conducted over the SIP PBX line.
3. External call from the branch office into the local telephone network. The dialed number 0 555 555 matches the route 0# (3) in the call routing table. The call router removes the 0 outside-line access prefix, adds the area code for the local telephone network and makes the call to 0241 555 555 via the ISDN line.
4. External call from the branch office into a national telephone network. The dialed number 0 555 555 matches the route 00# (2) in the call routing table. The call router directs the call to the SIP PBX line **unchanged**. Only now does the SIP PBX remove the 0 outside-line access prefix and directs the call to 0123 555 555 via the ISDN exchange line.

1.16.4 VoIP connectivity between sites without a SIP PBX

Companies with widely dispersed offices and without their own SIP PBX can also take advantage of VoIP site-to-site connectivity. In this "Peer-to-Peer" scenario, a LANCOM VoIP router has been implemented at two locations.

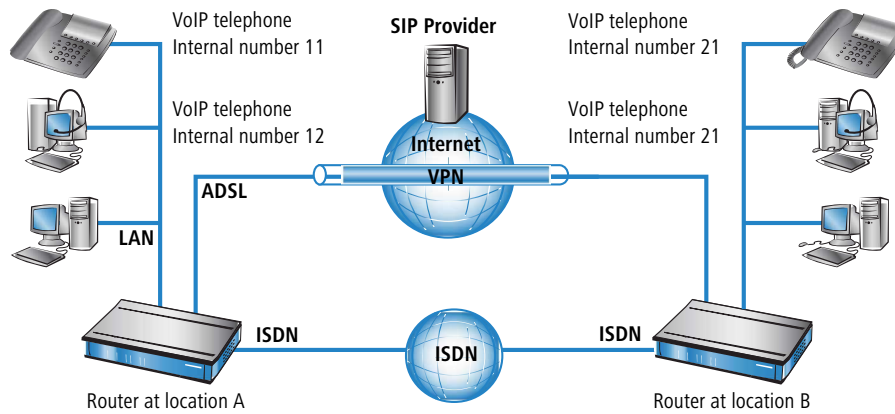

Objective

- Internal telephony at and between both locations.
- External telephony via the SIP provider with backup over ISDN.
- Calls to emergency and service numbers via ISDN.

Requirements

- LANCOM connected to the LAN and WAN, an ISDN TE interface is linked to the ISDN NTBA.
- The Internet connection has been set up by means of a VPN tunnel, as has the network connection between the two locations. All terminal devices can contact one another with the IP addresses used.
- A dialing plan with a unique internal telephone number for each piece of terminal equipment to be connected. For each site, a separate number range is used; in this example, the internal numbers for location A begin with a 1 and the internal numbers for location B begin with a 2.
- Each site has a SIP provider account.

Configuring the device

The following table provides a summary of the information required for configuration and where it can be entered. Basically, all that is needed is a SIP PBX line for each location that is correspondingly setup at the remote location

	LANCOM, site A	SIP phones, site A	LANCOM, site B	SIP phones, site B
Internal VoIP domain	location_A.internal	location_A.internal	location_B.internal	location_B.internal
Internal numbers		10 to 19		20 to 29
External SIP telephone number	✓		✓	
SIP account access data	✓		✓	
External ISDN telephone numbers (MSNs)	✓		✓	
Country and local area code	✓		✓	
SIP PBX line		LOCATION_B		LOCATION_A

	LANCOM, site A	SIP phones, site A	LANCOM, site B	SIP phones, site B
SIP PBX domain	location_B.internal		location_A.internal	
Call route	<ol style="list-style-type: none"> 1. Called number 2# 2. Destination line LOCATION_B 3. Destination number 2# 		<ol style="list-style-type: none"> 1. Called number 1# 2. Destination line LOCATION_A 3. Destination number 1# 	

ⓘ Although SIP PBX lines are the subject of the configuration presented here, you can still use this function even without a PBX.

Configuring the LANCOM in detail:

1. Under LANconfig, start the setup wizard for configuring the Voice Call Manager. Enable the options **SIP provider**, **SIP phone system** and **ISDN phone system**.

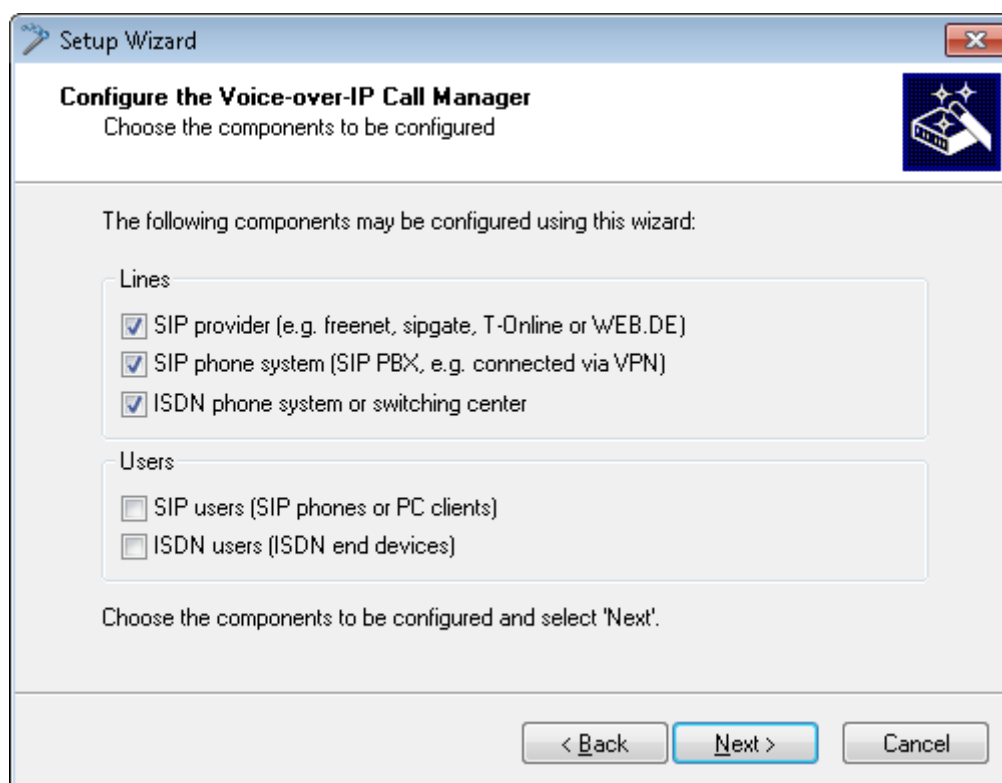

2. Configure the device as described in the preceding examples:
 - > A line to a SIP provider
 - > ISDN line with MSN mapping
 - > Area and country code for each location
3. Enter a unique domain for the local VoIP domain which describes the local VoIP area for the site. Both sites use **different** VoIP domains, e.g. location_A.internal and location_B.internal.
4. Configure the line to the SIP PBX with the following values:
 - > SIP PBX line name: Unique name for the line to the remote site.
 - > PBX SIP domain/realm: Internal VoIP domain of the remote site.

1 Voice over IP – VoIP

- › Registrar (FQDN or IP): Address for the LANCOM at the remote site, in the event that the device cannot be identified via DNS resolution of the VoIP domain (PBX SIP domain/realm).

 Use the private IP address that can be reached via VPN for the LANCOM here, not the public IP.

- › Leave the field for the shared password empty when registering to the SIP PBX.
- › Leave the field for the public PBX number empty.

- The call routing table suggested by the setup wizard automatically allows international and national long distance calls to be made via the remote site's line, local calls are routed via ISDN.

In addition, a **default route** directs all numbers which cannot be resolved to the remote site's line.

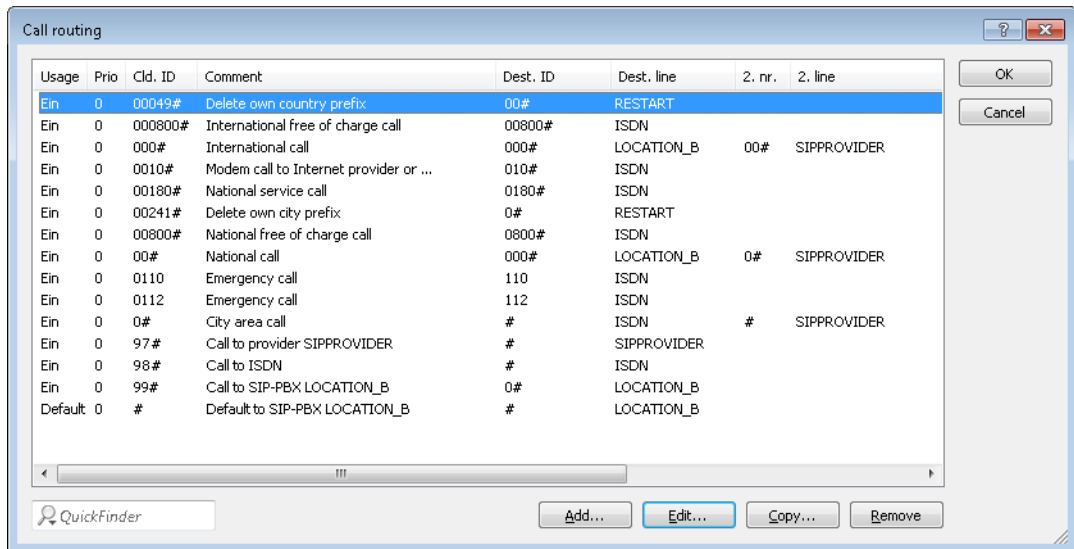

The screenshot shows a 'Call routing' window with a table of routing rules. The table has columns for Usage, Prio, Cld. ID, Comment, Dest. ID, Dest. line, 2. nr., and 2. line. The 'Delete own country prefix' rule is highlighted in blue.

Usage	Prio	Cld. ID	Comment	Dest. ID	Dest. line	2. nr.	2. line
Ein	0	00049#	Delete own country prefix	00#	RESTART		
Ein	0	000800#	International free of charge call	00800#	ISDN		
Ein	0	000#	International call	000#	LOCATION_B	00#	SIPPROVIDER
Ein	0	0010#	Modem call to Internet provider or ...	010#	ISDN		
Ein	0	00180#	National service call	0180#	ISDN		
Ein	0	00241#	Delete own city prefix	0#	RESTART		
Ein	0	00800#	National free of charge call	0800#	ISDN		
Ein	0	00#	National call	000#	LOCATION_B	0#	SIPPROVIDER
Ein	0	0110	Emergency call	110	ISDN		
Ein	0	0112	Emergency call	112	ISDN		
Ein	0	0#	City area call	#	ISDN	#	SIPPROVIDER
Ein	0	97#	Call to provider SIPPROVIDER	#	SIPPROVIDER		
Ein	0	98#	Call to ISDN	#	ISDN		
Ein	0	99#	Call to SIP-PBX LOCATION_B	0#	LOCATION_B		
Default	0	#	Default to SIP-PBX LOCATION_B	#	LOCATION_B		

- Adapt the suggested call routing table in order to make international and national long distance calls via the SIP provider line with backup over ISDN. When doing so, please observe that the 0 preceding the number needs to be removed.

After adaptation for international and national long distance calls, the call routing table appears as follows:

Usage	Prio	Cld. ID	Comment	Dest. ID	Dest. line	2. nr.	2. line
Ein	0	00049#	Delete own country prefix	00#	RESTART		
Ein	0	000800#	International free of charge call	00800#	ISDN		
Ein	0	000#	International call	000#	SIPPROVIDER	00#	ISDN
Ein	0	0010#	Modem call to Internet provider or ...	010#	ISDN		
Ein	0	00180#	National service call	0180#	ISDN		
Ein	0	00241#	Delete own city prefix	0#	RESTART		
Ein	0	00800#	National free of charge call	0800#	ISDN		
Ein	0	00#	National call	000#	SIPPROVIDER	0#	ISDN
Ein	0	0110	Emergency call	110	ISDN		
Ein	0	0112	Emergency call	112	ISDN		
Ein	0	0#	City area call	#	ISDN	#	SIPPROVIDER
Ein	0	97#	Call to provider SIPPROVIDER	#	SIPPROVIDER		
Ein	0	98#	Call to ISDN	#	ISDN		
Ein	0	99#	Call to SIP-PBX LOCATION_B	0#	LOCATION_B		
Default	0	#	Default to SIP-PBX LOCATION_B	#	LOCATION_B		

- In this state, all calls that cannot be resolved by the call routing table and which do not have a corresponding entry in the local user list are automatically forwarded to the remote site.

If this is not desired, for example where more than two sites are connected in this way, an additional entry can be used to detect the internal calls to a particular site. To achieve this, make a new entry (for the number range 20 to 29 at site B) in the call routing table with the following values:

1 Voice over IP – VoIP

- Called number / name: e.g. 2# for all numbers that begin with a 2.
- Number / name: The called number is used unchanged as a destination number, e.g. in this case 2#.
- Line: Enter the SIP PBX line for the remote location here, i.e. LOCATION_B.

In doing so, the default route is adjusted so that all numbers which cannot be resolved are transmitted via ISDN.

After adaptation, the call routing table appears as follows:

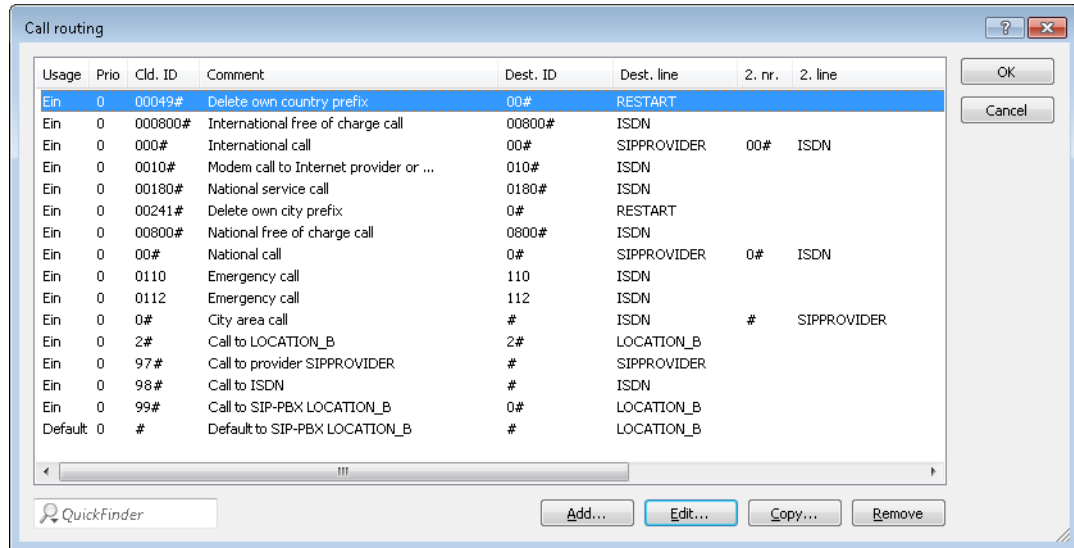

i This entry for LOCATION_B is placed well down toward the end of the call routing table so as not to affect the more general rules. However, for interaction with the other routes, verify that only the internal numbers for the remote site are directed to the respective line.

Configuring the VoIP terminal equipment

The VoIP terminal equipment is configured as described in the preceding examples with internal VoIP domains and internal numbers for the local site.

Call routing procedure for outgoing calls

For this application, most calls take place as described in the preceding examples. Internal calls between locations are resolved as follows:

	User	Dials	Correct call route	Correct user	Mapping, number in use	Destination line
1	VoIP telephone location A	21	2#	none	21	LOCATION_B

1. Internal call between two VoIP terminal devices at locations A and B. The dialed number 21 matches the route 5 2# in the call routing table. The call router sends the call out over the line to the remote SIP PBX without changing the number.

1.16.5 SIP trunking

In telecommunications jargon, trunking is the process by which several lines or connections are combined into one shared line. In the world of VoIP, SIP providers are increasingly offering products which provide the ability to make several calls simultaneously using a single account. Together with the possibility of being able to contact SIP participants via a shared

switchboard number with individual extensions (DDIs), these types of accounts are also becoming attractive for business customers.

There are two possible options when using a SIP account with trunking:

- The customer retains his previous ISDN connection, along with any corresponding telephone numbers from the telephone company, and sets up an additional account having a separate number range with a SIP provider.
- The customer ports the numbers used thus far from the telephone company to the SIP provider and from then on uses the same numbers using SIP.

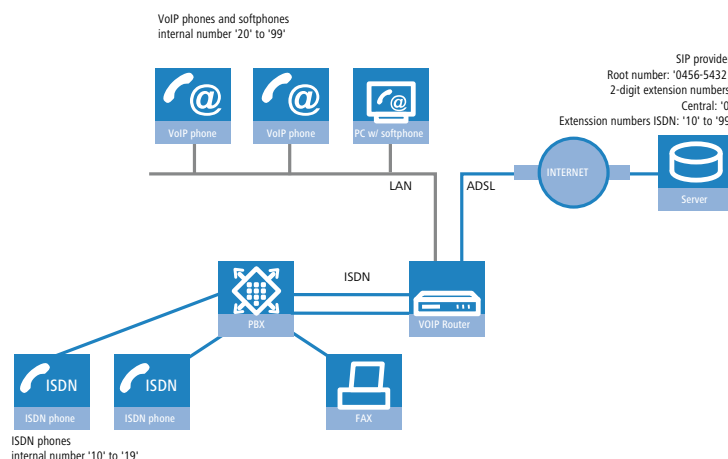

In this example we will take a look at a company planning to add a SIP trunking account with up to 10 extension numbers. The ISDN terminal devices with point-to-point line extensions used thus far can be retained. All new employees are to be issued with a SIP telephone with an extension via the SIP account.

Unique extensions are used since staff members have to be able to call one another internally. In order to migrate smoothly towards SIP, all ISDN terminal devices are to be contactable using their extension number in **parallel** with the switchboard number of the SIP account. An ISDN telephone should respond to calls to 0456-54321 12.

Outgoing calls should be directed via the SIP account.

Objectives in implementing the LANCOM VoIP router

- Connection of additional SIP terminal devices
- Internal calls between ISDN and SIP terminal devices.
- Low-cost calls by using a shared SIP account.

Requirements

- LANCOM connected to the LAN and WAN (via DSL/ADSL), ISDN NT interface(s) are connected to an ISDN PBX.
- The Internet connection has been set up. All terminal devices can contact one another with the IP addresses used.
- A dialing plan with a unique internal telephone number for each piece of terminal equipment to be connected.

Configuring the device

This is how the LANCOM is configured for operation at a point-to-point line:

1. When configuring SIP clients, all you need to enter are the internal VoIP domain of the LANCOM VoIP router and the associated internal phone number. The extension numbers previously used for the ISDN terminal devices remain unallocated.
2. A SIP provider line is created for the SIP account. The 'Trunk' option is selected as the mode for this line.
3. Routing of calls is governed by the call routing table. When using the Wizards available with LANconfig, the call routing table is preconfigured such that all out-going calls from ISDN and SIP devices are made using the SIP trunk account.

Process of call routing

In this example, call routing benefits from the unique internal telephone numbers.

- For incoming calls, the only information passed to the LANCOM VoIP router is the DDI. Since the DDI and internal numbers are the same in this example, an extension number can be used to put through calls to locally registered SIP users or to dynamic ISDN users.

ⓘ If the reported DDIs cannot or should not be used directly as internal numbers, the ISDN and SIP mapping tables are used to set up the necessary telephone number translations.

- In the default setting after using the Wizards, SIP is taken to be the normal destination line (with the exception of local calls and special numbers). Local calls, for example, may be switched to SIP by changing an entry in the call routing table.

ⓘ In this case, the SIP number is displayed at the subscribers on the other side of the connection, even if the call originates from an ISDN terminal device.

1.16.6 Block outgoing calls to service numbers

You have the option to block certain call numbers (e.g. charged hotlines such as 0900) with the following call route:

For the calling number, specify a registered client to restrict the rule to those calls made by the corresponding user.

By setting the source line to "User.#", "User.ISDN", "User.SIP" or "User.Analog", you have the option of restricting the rule to the corresponding subscriber, irrespective of the telephone number they are using.

1.16.7 Rejecting incoming calls

Incoming calls from charged hotlines (0900), for example, can be rejected with the following call route:

Call routing - New Entry

Entry active / default line: Active

Priority: 10

Called number: #

Comment: No calls from hotlines

Mapping

Calling number: []

Destination number: #

Destination line: REJECT Select

If the line is not available, you can define additional destinations here.

2. dest. number: []

2. dest. line: [] Select

3. dest. number: []

3. dest. line: [] Select

Filters

In addition to the called number you can define further filters for this entry:

Called domain: [] Select

Calling number: 0049900#

Calling domain: [] Select

Source line: SIPPROVIDER Select

OK Cancel

Select a source line, e.g. a registered SIP line, to restrict the rule to calls that are signaled via this line.

1.16.8 Reject calls without a calling number

Set the following call route to reject incoming calls that do not contain a calling number:

Call routing - New Entry

Entry active / default line: Active

Priority: 10

Called number: #

Comment: Calls w/o number

Mapping

Calling number: []

Destination number: #

Destination line: REJECT [Select]

If the line is not available, you can define additional destinations here.

2. dest. number: []

2. dest. line: [] [Select]

3. dest. number: []

3. dest. line: [] [Select]

Filters

In addition to the called number you can define further filters for this entry:

Called domain: [] [Select]

Calling number: EMPTY

Calling domain: [] [Select]

Source line: SIPPROVIDER [Select]

OK Cancel

Select a source line, e.g. a registered SIP line, to restrict the rule to calls that are signaled via this line.

1.16.9 Forwarding calls without a calling number

Set the following call route to redirect incoming calls that do not contain a calling number, e.g. to an answering machine:

Select a source line, e.g. a registered SIP line, to restrict the rule to calls that are signaled via this line.

1.17 Diagnosis of VoIP connections

1.17.1 SIP traces

Trace output can be used to check the internal processes in LANCOM devices during or after configuration. With a SIP trace, all of the SIP information is displayed that is exchanged between a LANCOM VoIP router and a SIP provider or an upstream SIP telephone system. The SIP trace is activated with the following command:

```
trace + sip-packet
```

1.17.2 Connection diagnosis with LANmonitor

LANmonitor displays a wealth of information about calls switched in the LANCOM:

- > Information about the registered users.
- > Information about the lines available.
- > Information about current calls, including the translation of telephone numbers and domains by the Call Manager.

1 Voice over IP – VoIP

➤ Information about the fixed and automatic QoS bandwidth reservations and settings.

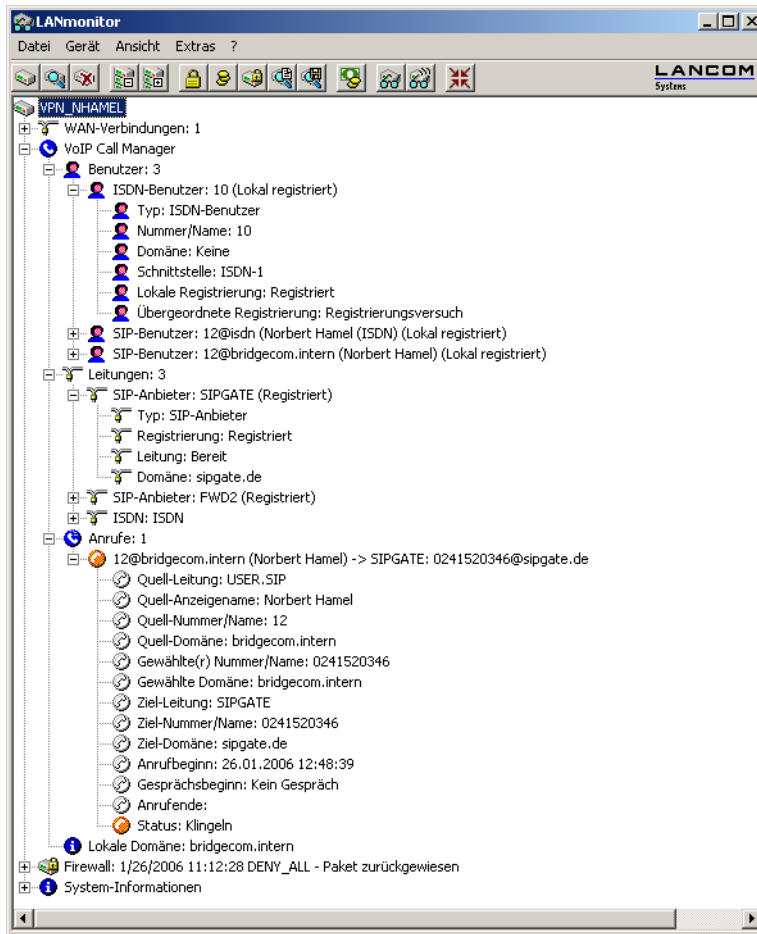

1.18 VoSIP support in the Voice Call Manager

LCOS supports Voice over Secure IP (VoSIP). This function enables you to encrypt the signaling and voice data. From LCOS version 9.20, you can use VoSIP on all LANCOM business VoIP routers.

Signaling encryption

This setting determines the protocol used for signaling encryption (SIP/SIPS) for communications with the provider.

Automatic

NAPTR (Naming Address Pointer) records are used for DNS resolution. In the DNS data, the provider specifies the use of transport protocols such as UDP, TCP or TLS. The provider can also specify weights or priorities.

If TLS is specified as the transport protocol for signaling encryption by NAPTR, voice encryption is also used automatically, regardless of the explicit configuration setting of voice encryption.

No (UDP)

All SIP packets are transmitted connectionless. Most providers support this setting.

No (TCP)

All SIP packets are transmitted connection-oriented. The device establishes a TCP connection to the provider and maintains it for as long as it stays registered. Specialized providers, such as the providers of SIP trunks, support or force this setting.

TLS

Transmission is the same as with TCP, but all of the SIP packets are encrypted all the way to the provider. The TLS version selected in the configuration is taken as the minimum requirement for TLS encryption.

Speech encryption

This setting determines if and how the speech data (RTP/SRTP) is encrypted when communicating with the provider.

Speech encryption

Reject	Encryption is not available for outgoing calls. Incoming calls with an encryption proposal are rejected. The speech channel is not encrypted.
Ignore	Encryption is not available for outgoing calls. Incoming calls with an encryption proposal are accepted. The speech channel is not encrypted.
Prefer	Encryption is offered for outgoing calls. Incoming calls without an encryption proposal are accepted. The speech channel is only encrypted if the remote peer also supports encryption.
Force	Encryption is offered for outgoing calls. Incoming calls without an encryption proposal are rejected. The speech channel is either encrypted or is not established.

 If you require the encrypted transmission of speech data, the signaling must also use an encrypted channel. Please note that the use of SRTP is no guarantee of end-to-end encryption.

1.19 Auto provisioning LANCOM DECT 510 IP

LCOS facilitates the automatic installation and configuration of the base station with up to 6 DECT handsets. When connected to a LANCOM router, the LANCOM DECT 510 IP makes it easy to register the handsets and to assign them individual phone numbers.

The LANCOM DECT 510 IP base station can be configured via WEBconfig. This is not strictly required. If provisioning is enabled, your router configures the base station automatically. To enable the provisioning on your router, navigate to the LANconfig menu **Management > General > Advanced > Enable the provisioning server** and set the value to **Yes**. At the console, you set the corresponding parameters under **Setup > Provisioning-Server > Operating (SNMP-ID 2.103.1)**.

 For the automatic configuration of the LANCOM DECT 510 IP, the base station needs to be connected to the router and the handsets registered with the base station.

You also have the option to configure the base station by means of the All-IP Wizard. Simply follow the instructions provided by the Wizard.

1.19.1 Configuring DECT base stations and handsets with LANconfig

To configure the DECT base station in LANconfig, go to **Voice Call Manager > Users > DECT base stations** and add a new entry to the table.

! If auto-provisioning is to apply for all of the LANCOM DECT 510 IPs, or if they should all be configured the same, there is no need for any further entries in this table. The default entry takes care of everything.

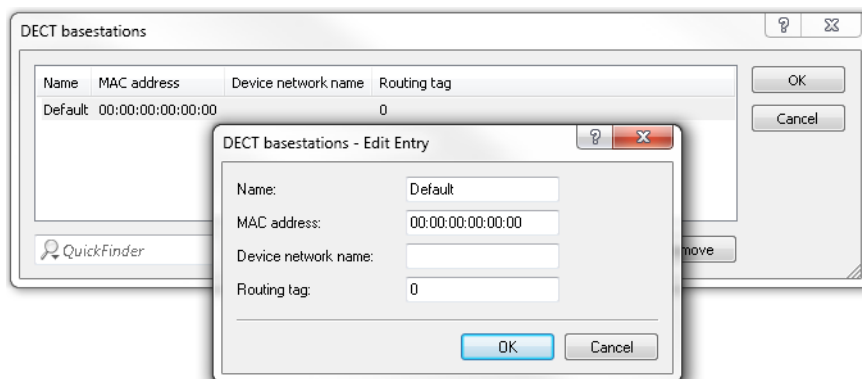

Name

Specify a unique name for this base station here.

MAC address

Enter the MAC address of the base station.

! If you wish to permit communications with any MAC address, enter 00:00:00:00:00:00 (default).

Network name

Here you optionally specify a network name that is displayed with the base station in the network.

Routing tag

The interface tag allows you to restrict the auto-provisioning of LANCOM DECT base stations to a specific network. This is particularly useful if your network contains IP addresses that are open to the public (e.g. via a Public Spot or DMZ). This restriction prevents SIP access credentials for the DECT base station from being unintentionally transmitted to third-party devices.

! If you wish to use this service for all networks, enter the routing tag "0" here.

To configure the DECT handsets in LANconfig, go to **Voice Call Manager > Users > DECT handsets** and add a new entry to the table.

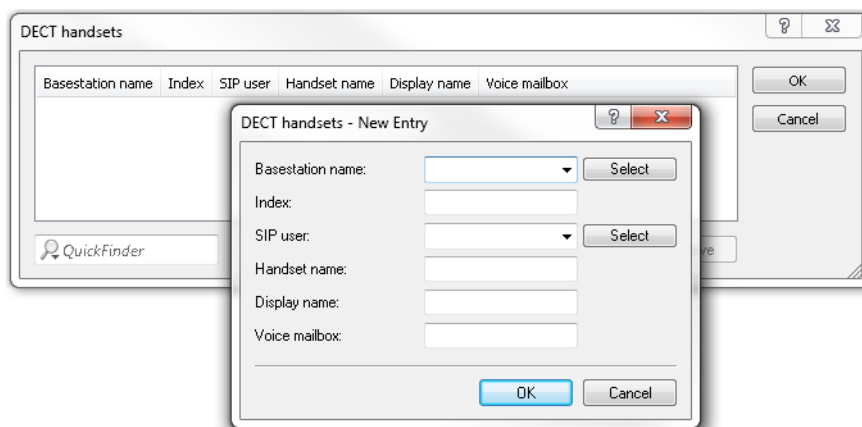

Base station name

Here you select the base station where the corresponding handset is registered.

Index

Enter here the number of the corresponding handset (e.g. "0" for handset 1, "1" for handset 2, etc.).

SIP user

Select the phone number of the handset here.

Handset name

Here you set the name to be shown in the display of the handset.

Display name

Here you set the name to be sent to a caller.

Voice mailbox

Enter the phone number of your voice mailbox here. This phone number is dialed by pressing and holding the button "1" on the handset.